

# *Super Audio CD/ DVD RECEIVER*

---

Operating instructions

GB

使用説明書

CT



## AVD-S10

# WARNING

## To prevent fire or shock hazard, do not expose the unit to rain or moisture.

Do not install the appliance in a confined space, such as a bookcase or built-in cabinet.

To prevent fire, do not cover the ventilation of the apparatus with news papers, table-cloths, curtains, etc. And don't place lighted candles on the apparatus.

To prevent fire or shock hazard, do not place objects filled with liquids, such as vases, on the apparatus.

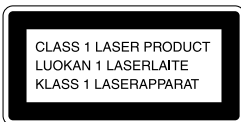

This appliance is classified as a CLASS 1 LASER product. The label is located on the rear exterior.

The following caution label is located inside the receiver.



Don't throw away the battery with general house waste, dispose of it correctly as chemical waste.

## Precautions

### Safety

- If anything falls into the cabinet, unplug the unit and have it checked by qualified personnel before operating it any further.
- The unit is not disconnected from the mains as long as it is connected to the mains outlet, even if the unit itself has been turned off.
- Unplug the unit from the wall outlet if you do not intend to use it for an extended period of time. To disconnect the cord, pull it out by the plug, never by the cord.

### Installing

- Allow adequate air circulation to prevent internal heat buildup.
- Do not place the unit on surfaces (rugs, blankets, etc.) or near materials (curtains, draperies) that may block the ventilation slots.
- Do not install the unit near heat sources such as radiators, or air ducts, or in a place subject to direct sunlight, excessive dust, mechanical vibration, or shock.
- Do not install the unit in an inclined position. It is designed to be operated in a horizontal position only.
- Keep the unit and discs away from equipment with strong magnets, such as microwave ovens, or large loudspeakers.
- Do not place heavy objects on the unit.
- If the unit is brought directly from a cold to a warm location, moisture may condense inside the Compact AV System and cause damage to the lenses. When you first install the unit, or when you move it from a cold to a warm location, wait for about 30 minutes before operating the unit.



## Welcome!

Thank you for purchasing this Sony Super Audio CD/DVD receiver. Before operating this receiver, please read this manual thoroughly and retain it for future reference.

# Precautions

## On safety

Should any solid object or liquid fall into the cabinet, unplug the receiver and have it checked by qualified personnel before operating it any further.

## On power sources

- The unit is not disconnected from the AC power source (mains) as long as it is connected to the wall outlet, even if the unit itself has been turned off.
- AC power cord must be changed only at the qualified service shop.

## On placement

- Place the receiver in a location with adequate ventilation to prevent heat build-up in the receiver.
- At high volume, over long periods of time, the cabinet becomes hot to the touch. This is not a malfunction. However, touching the cabinet should be avoided. Do not place the unit in a confined space where ventilation is poor as this may cause overheating.
- Do not block the ventilation slots by putting anything on the receiver. The receiver is equipped with a high power amplifier. If the ventilation slots on the top surface are blocked, the unit can overheat and malfunction.
- Do not place the receiver on a soft surface such as a rug that might block the ventilation holes on the bottom.
- Do not place the receiver in a location near heat sources, or in a place subject to direct sunlight, excessive dust, or mechanical shock.

## On operation

- If the receiver is brought directly from a cold to a warm location, or is placed in a very damp room, moisture may condense on the lenses inside the receiver. Should this occur, the receiver may not operate properly. In this case, remove the disc and leave the receiver turned on for about half an hour until the moisture evaporates.
- When you move the receiver, take out any discs. If you don't, the disc may be damaged.

- For power saving purposes, the receiver can be completely turned off by the POWER button on the main unit. Though the LED remains lit for a while, the receiver is completely off.

## On adjusting volume

Do not turn up the volume while listening to a section with very low level inputs or no audio signals. If you do, the speakers may be damaged when a peak level section is played.

## On cleaning

Clean the cabinet, panel, and controls with a soft cloth slightly moistened with a mild detergent solution. Do not use any type of abrasive pad, scouring powder or solvent such as alcohol or benzene.

If you have any questions or problems concerning your receiver, please consult your nearest Sony dealer.

## On cleaning discs

Do not use a commercially available CD/DVD cleaning disc. It may cause a malfunction.

## On your TV's colour

If the speakers should cause the TV screen to have colour irregularity, turn off the TV at once then turn it on after 15 to 30 minutes. If colour irregularity should persist, place the speakers further away from the set.

### IMPORTANT NOTICE

Caution: This receiver is capable of holding a still video image or on-screen display image on your television screen indefinitely. If you leave the still video image or on-screen display image displayed on your TV for an extended period of time you risk permanent damage to your television screen. Projection televisions are especially susceptible to this.





# Table of Contents

WARNING .....	2
Welcome! .....	2
Precautions .....	3
About this Manual .....	6
This receiver Can Play the Following Discs .....	6
Notes about the Discs .....	8
Index to Parts and Controls .....	9
Guide to the Control Menu Display (Magic Pad) .....	13
<hr/>	
<b>Getting Started .....</b>	<b>15</b>
Quick Overview .....	15
Unpacking .....	15
Inserting Batteries into the Remote .....	16
Step 1: Speaker System Hookup .....	16
Step 2: Antenna Hookups .....	19
Step 3: TV and Video Component Hookups .....	21
Speaker Setup .....	23
Presetting Radio Stations .....	28
<hr/>	
<b>Playing Discs .....</b>	<b>30</b>
Playing Discs .....	30
Resuming Playback from the Point Where You Stopped the Disc (Resume Play) .....	31
Using the DVD's Menu .....	32
Playing VIDEO CDs with PBC Functions (PBC Playback) .....	33
Creating Your Own Programme (Programme Play) .....	34
Playing in random order (Shuffle Play) .....	36
Playing repeatedly (Repeat Play) .....	36
<hr/>	
<b>Searching for a Scene .....</b>	<b>38</b>
Searching for a Particular Point on a Disc (Scan, Slow-motion Play) .....	38
Searching for a Title/Chapter/Track/Index/Scene .....	39
<hr/>	
<b>Viewing Information About the Disc .....</b>	<b>41</b>
Viewing the Playing Time and Remaining Time on the Front Panel Display ....	41
Checking the Playing Time and Remaining Time .....	42

<b>Sound Adjustments</b> .....	<b>44</b>
Changing the Sound .....	44
Automatically decoding the input audio signal (Auto Format Decode) .....	46
Enjoying Surround Sound .....	46
Using only the front speakers (2 Channel Stereo) .....	50
Adjusting the level parameters .....	50
<hr/>	
<b>Enjoying Movies</b> .....	<b>51</b>
Changing the Angles .....	51
Displaying the Subtitles .....	52
Checking the Play Information (ADVANCED) .....	53
<hr/>	
<b>Using Various Additional Functions</b> .....	<b>54</b>
Locking Discs (CUSTOM PARENTAL CONTROL, PARENTAL CONTROL) ...	54
<hr/>	
<b>Other Operations</b> .....	<b>59</b>
Controlling the TV with the Supplied Remote .....	59
Watching the Video or other Unit .....	60
Listening to the Radio .....	61
Naming Preset Stations .....	62
<hr/>	
<b>Settings and Adjustments</b> .....	<b>63</b>
Using the Setup Display .....	63
Setting the Display or Sound Track Language (LANGUAGE SETUP) .....	64
Settings for the Display (SCREEN SETUP) .....	65
Custom Settings (CUSTOM SETUP) .....	66
Settings for the Speakers (SPEAKER SETUP) .....	67
<hr/>	
<b>Additional Information</b> .....	<b>71</b>
Troubleshooting .....	71
Self-diagnosis Function (When letters/numbers appear on the front panel display) .....	74
Glossary .....	74
Specifications .....	77
Language Code List .....	79
DVD Setup Menu List .....	80
Index .....	81

# About this Manual

- The instructions in this manual describe the controls on the remote. You can also use the controls on the receiver if they have the same or similar names as those on the remote.
- The icons used in this manual are explained below:

Icon	Meaning	Icon	Meaning
	Functions available in DVD video mode		Functions available in Super Audio CD and Audio CD mode
	Functions available in VIDEO CD mode		Functions available in CD mode
			More convenient features

# This receiver Can Play the Following Discs

Format of discs	
DVD VIDEO	
Super Audio CD	
VIDEO CD	
Music CD	

The “DVD VIDEO” logo is a trademark.

## Terms for discs

- **Title**  
The longest sections of a picture or music feature on a DVD, movie, etc., in video software, or the entire album in audio software. Each title is assigned a title number enabling you to locate the title you want.
- **Chapter**  
Sections of a picture or a music piece that are smaller than titles. A title is composed of several chapters. Each chapter is assigned a chapter number enabling you to locate the chapter you want. Depending on the disc, no chapters may be recorded.
- **Track**  
Sections of a picture or a music piece on a VIDEO CD, Super Audio CD, or CD. Each track is assigned a track number enabling you to locate the track you want.
- **Index (Super Audio CD, CD) / Video Index (VIDEO CD)**  
A number that divides a track into sections to easily locate the point you want on a VIDEO CD, Super Audio CD, or CD. Depending on the disc, no indexes may be recorded.
- **Scene**  
On a VIDEO CD with PBC functions (page 33), the menu screens, moving pictures and still pictures are divided into sections called “scenes.” Each scene is assigned a scene number enabling you to locate the scene you want.

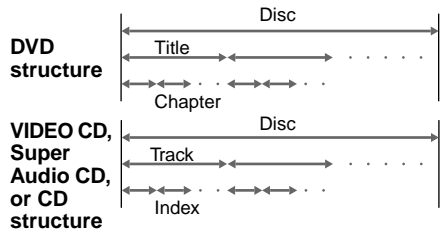

## Note on PBC (Playback Control) (VIDEO CDs)

This receiver conforms to Ver. 1.1 and Ver. 2.0 of VIDEO CD standards. You can enjoy two kinds of playback depending on the disc type.

Disc type	You can
VIDEO CDs without PBC functions (Ver. 1.1 discs)	Enjoy video playback (moving pictures) as well as music.
VIDEO CDs with PBC functions (Ver. 2.0 discs)	Play interactive software using menu screens displayed on the TV screen (PBC Playback), in addition to the video playback functions of Ver. 1.1 discs. Moreover, you can play high-resolution still pictures, if they are included on the disc.

## Region code

Your receiver has a region code printed on the back of the unit and will only play DVDs labelled with the same region code.

DVDs labelled  will also play on this receiver.

If you try to play any other DVD, the message “Playback prohibited by area limitations.” will appear on the TV screen. Depending on the DVD, no region code indication may be labelled even though playing the DVD is prohibited by area restrictions.

## Examples of discs that the receiver cannot play

The receiver cannot play the following discs:

- CD-ROMs (PHOTO CDs included)
- All CD-Rs other than music and VCD formatted CD-Rs
- Data part of CD-Extras
- DVD-ROMs
- DVD Audio discs
- A DVD with a different region code (page 7, 76).
- A disc that has a non-standard shape (e.g., card, heart)
- A disc with paper or stickers on it.
- A disc that has the adhesive, cellophane tape, or a sticker still left on it.

### Note

Some CD-Rs or CD-RWs cannot be played on this receiver depending upon the recording quality or physical condition of the disc, or the characteristics of the recording device.

Furthermore, the disc will not play if it has not been correctly finalized. For more information, see the operating instructions for the recording device.

## Note on playback operations of DVDs and VIDEO CDs

Some playback operations of DVDs and VIDEO CDs may be intentionally set by software producers. Since this receiver plays DVDs and VIDEO CDs according to the disc contents the software producers designed, some playback features may not be available. Also, refer to the instructions supplied with the DVDs or VIDEO CDs.

## Copyrights

This product incorporates copyright protection technology that is protected by method claims of certain U.S. patents, other intellectual property rights owned by Macrovision Corporation, and other rights owners. Use of this copyright protection technology must be authorized by Macrovision Corporation, and is intended for home and other limited viewing uses only unless otherwise authorized by Macrovision Corporation. Reverse engineering or disassembly is prohibited.

This receiver incorporates Dolby\* Digital, Pro Logic Surround, and the DTS\*\* Digital Surround System.

- \* Manufactured under license from Dolby Laboratories. “Dolby”, “Pro Logic”, and the double-D symbol are trademarks of Dolby Laboratories. Confidential unpublished works. © 1992-1997 Dolby Laboratories. All rights reserved.
- \*\* Manufactured under license from Digital Theater Systems, Inc. US Pat. No. 5,451,942 and other worldwide patents issued and pending. “DTS” and “DTS Digital Surround” are trademarks of Digital Theater Systems, Inc. © 1996 Digital Theater Systems, Inc. All rights reserved.

## Notes about the Discs

### On handling discs

- To keep the disc clean, handle the disc by its edge. Do not touch the surface.
- Do not stick paper or tape on the disc.



- Do not expose the disc to direct sunlight or heat sources such as hot air ducts, or leave it in a car parked in direct sunlight as the temperature may rise considerably inside the car.
- After playing, store the disc in its case.

### On cleaning

- Before playing, clean the disc with a cleaning cloth. Wipe the disc from the centre out.



- Do not use solvents such as benzene, thinner, commercially available cleaners, or anti-static spray intended for vinyl LPs.



# Index to Parts and Controls

For more information, refer to the pages indicated in parentheses.

## Front Panel

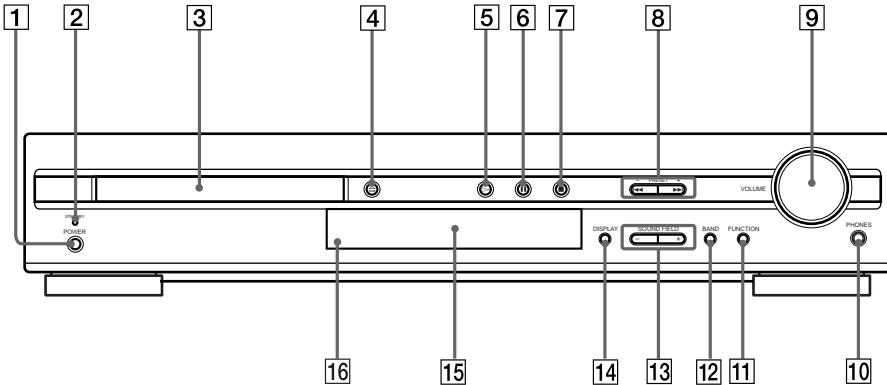

- 1** POWER switch (30)
- 2** STANDBY indicator (30)
- 3** Disc tray (30)
- 4** ⏏ (open/close) (30)
- 5** ▶ (play) (30)
- 6** ⏸ (pause) (31)
- 7** ■ (stop) (30)
- 8** ⏪/⏩, PRESET +/- (28, 31)

- 9** VOLUME control (30)
- 10** PHONES jack (30)
- 11** FUNCTION (60)
- 12** BAND (28)
- 13** SOUND FIELD +/- (46)
- 14** DISPLAY (61)
- 15** Front panel display (10)
- 16** 📶 (remote sensor) (16)

## Front Panel Display

### When playing back a DVD

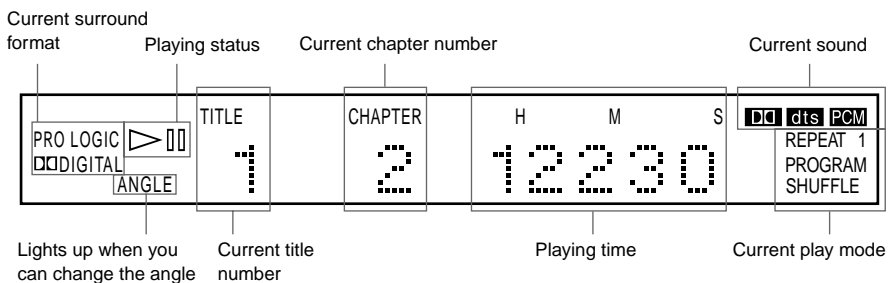

### When playing back a Super Audio CD, CD, or VIDEO CD

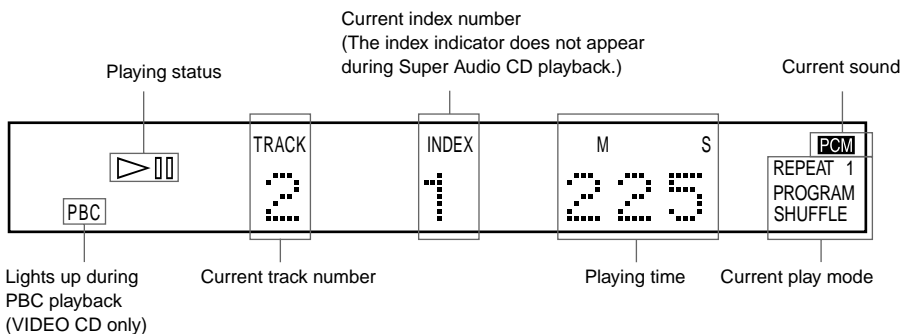

### When listening to the radio

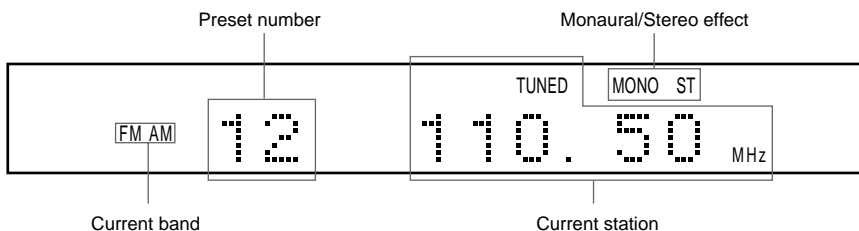

## Rear Panel

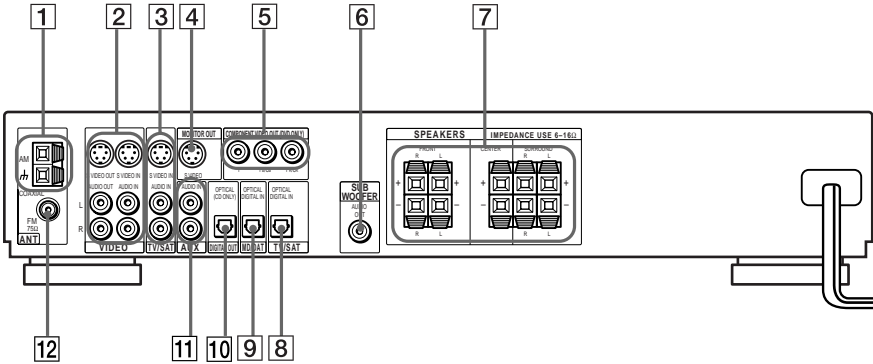

- |  |   |
|--|---|
| <p><b>1</b> AM antenna (19)</p> <p><b>2</b> VIDEO (S VIDEO/AUDIO L/R IN/OUT) jacks (21)</p> <p><b>3</b> TV/SAT (S VIDEO/AUDIO L/R IN) jacks (21)</p> <p><b>4</b> MONITOR OUT (S VIDEO) jack (21)</p> <p><b>5</b> COMPONENT VIDEO OUT (DVD ONLY) jacks (21)</p> | <p><b>6</b> SUBWOOFER AUDIO OUT jack (17)</p> <p><b>7</b> SPEAKERS jacks (17)</p> <p><b>8</b> TV/SAT (OPTICAL DIGITAL IN) jack</p> <p><b>9</b> MD/DAT (OPTICAL DIGITAL IN) jack</p> <p><b>10</b> DIGITAL OUT (OPTICAL (CD ONLY)) jack</p> <p><b>11</b> AUX (AUDIO IN L/R) jacks</p> <p><b>12</b> FM 75Ω COAXIAL antenna jack (20)</p> |
|--|---|

## Remote

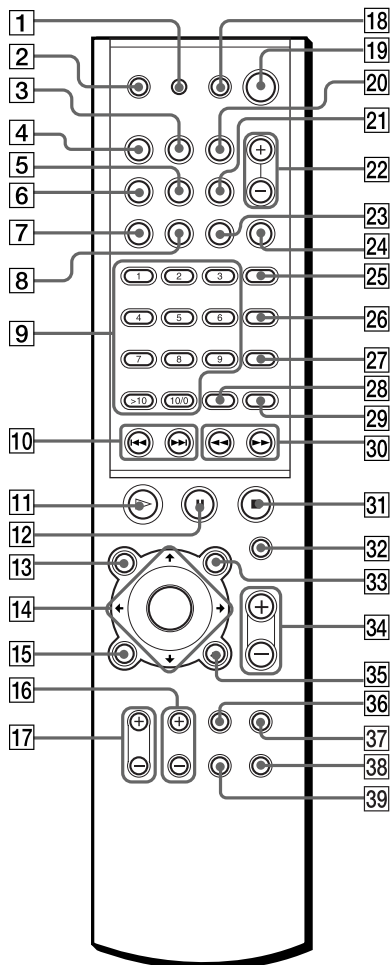

### Note

This remote control glows in the dark. However, before glowing, the remote must be exposed to light for awhile.

- 1 RM SET UP (59)
- 2 OPEN/CLOSE (30)
- 3 BAND (28)
- 4 FUNCTION (60)
- 5 MEMORY (28)
- 6 NAME (62)
- 7 PLAY MODE (34)
- 8 REPEAT (37)
- 9 Number buttons (32)
- 10 ◀◀/▶▶, PRESET +/- (28, 31)
- 11 ▷ (play) (30)
- 12 || (pause) (31)
- 13 DVD TOP MENU (32)
- 14 ◀/▶/⏪/⏩/ENTER (24)
- 15 DVD DISPLAY (13, 36)
- 16 TV CH +/- (60)
- 17 TV VOL +/- (60)
- 18 TV I/⏻ (on/standby) (60)
- 19 I/⏻ (on/standby) (30)
- 20 STEREO/MONO (61)
- 21 DISPLAY (61)
- 22 SOUND FIELD +/- (46)
- 23 TIME (41)
- 24 DIMMER (27)
- 25 AUDIO (44)
- 26 ANGLE (51)
- 27 SUBTITLE (52)
- 28 ENTER
- 29 CLEAR (35)
- 30 ◀◀/▶▶ (28, 38)
- 31 ■ (stop) (30)
- 32 MUTING (31)
- 33 DVD MENU (32)
- 34 VOLUME +/- (30)
- 35 ↶ RETURN (33)
- 36 TV/VIDEO (60)
- 37 AMP MENU (24)
- 38 DVD SETUP (64)
- 39 WIDE (60)





# Guide to the Control Menu Display (Magic Pad)

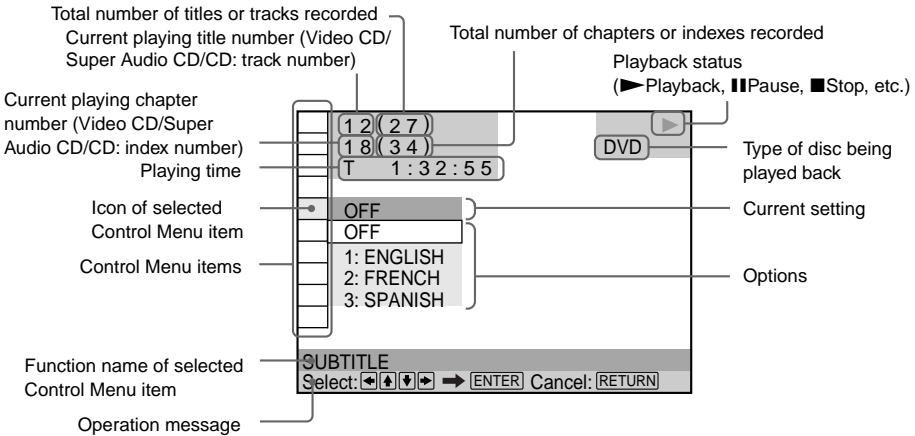





Use the Control Menu to select a function that you'd like to use. The Control Menu display appears when the DVD DISPLAY button is pressed. For details, refer to the page in parentheses.

## Control Menu



## List of Control Menu Items

 <b>TITLE (DVD only) (page 39)/ SCENE (only VIDEO CD in PBC playback) (page 39)/TRACK (VIDEO CD only) (page 39)</b>	Selects the title (DVD), the scene (VIDEO CD in PBC playback), or the track (VIDEO CD) to be played.
 <b>CHAPTER (DVD only) (page 39)/INDEX (VIDEO CD only) (page 39)</b>	Selects the chapter (DVD) or the index (VIDEO CD) to be played.
 <b>TRACK (Super Audio CD/CD only) (page 39)</b>	Selects the track (Super Audio CD/CD) to be played.
 <b>INDEX (Super Audio CD/CD only) (page 39)</b>	Selects the index (Super Audio CD/CD) to be played.
 <b>TIME/TEXT (page 40)</b>	Checks the elapsed time and the remaining playback time. Inputs the time code for picture and music searching. Displays the DVD or the Super Audio CD/CD text.

	<b>AUDIO (page 44)</b>	Changes the audio setting.
 52)	<b>SUBTITLE (DVD only) (page</b>	Displays the subtitles. Changes the subtitle language.
	<b>ANGLE (DVD only) (page 51)</b>	Changes the angle.
	<b>REPEAT (page 36)</b>	Plays the entire disc (all titles/all tracks) repeatedly, or one title/chapter/track repeatedly.
 (page 53)	<b>ADVANCED (DVD only)</b>	Checks the information (bit rate or layer) on the disc while playing a DVD.
	<b>CUSTOM PARENTAL CONTROL (page 54)</b>	Sets the disc to prohibit playing.
	<b>SETUP (page 64)</b>	CUSTOM Setup By using the Setup Display, you can make various adjustments to items such as picture and sound. You can also set a language for the subtitles and the Setup Display, among other things. RESET Returns the settings in "SETUP" to the default setting.

 Each time you press DVD DISPLAY, the Control Menu display changes as follows:

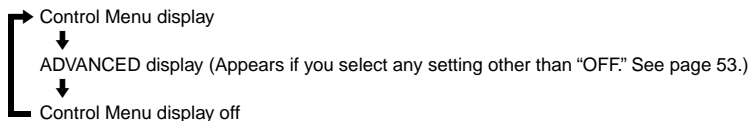

The Control Menu items are different depending on the disc.

 The Control Menu icon indicator lights up in green  →  when you select "REPEAT" unless you set the REPEAT PLAY setting to "OFF." The "ANGLE" indicator lights up in green only when the angles can be changed.

---

## Quick Overview

This chapter presents a quick overview so you can begin enjoying your new receiver right away. For selecting a language used in the on-screen display, refer to page 64. For selecting the aspect ratio of the TV to be connected, refer to page 65.

---

## Unpacking

Check that you have the following items:

- AM loop antenna (1)
- FM wire antenna (1)
- S Video cord (1)
- Remote Commander (remote) RM-SP10 (1)
- R6 (size AA) batteries (2)

---

## Inserting Batteries into the Remote

You can control the receiver using the supplied remote. Insert two R6 (size AA) batteries by matching the ⊕ and ⊖ ends on the batteries to the markings inside the compartment. When using the remote, point it at the remote sensor  on the receiver.

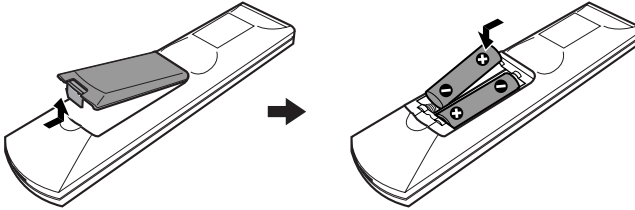

### Notes

- Do not leave the remote in an extremely hot or humid place.
- Do not use a new battery with an old one.
- Do not drop any foreign object into the remote casing, particularly when replacing the batteries.
- Do not expose the remote sensor to direct light from the sun or lighting apparatus. Doing so may cause a malfunction.
- If you do not use the remote for an extended period of time, remove the batteries to avoid possible damage from battery leakage and corrosion.

---

## Step 1: Speaker System Hookup

You can enjoy surround sound by connecting 5 speakers (front L/R speakers, centre speaker, rear L/R speakers) and active subwoofer to the receiver. If you do not connect 5 speakers and active subwoofer to the receiver, the receiver optimizes the surround signal depending on the number of connected speakers. When you connect 2 speakers to the receiver, connect the speakers to the SPEAKERS FRONT L/R jacks.

### Notes

- Be sure to match the speaker cord to the appropriate terminal: ⊕ to ⊕, ⊖ to ⊖, L to L, and R to R jack.
- Use the high performance speakers.
- Use the same size and performance speakers for the front, centre, and rear speakers.
- To obtain the best possible surround sound, specify the speaker parameters (number, distance, level, etc.) on page 23.



## Terminals for connecting the speakers

Connect the	To the
Front speakers	SPEAKERS FRONT L and R terminals
Rear speakers	SPEAKERS REAR L and R terminals
Centre speaker	SPEAKERS CENTER terminal
Subwoofer	SUBWOOFER AUDIO OUT terminal

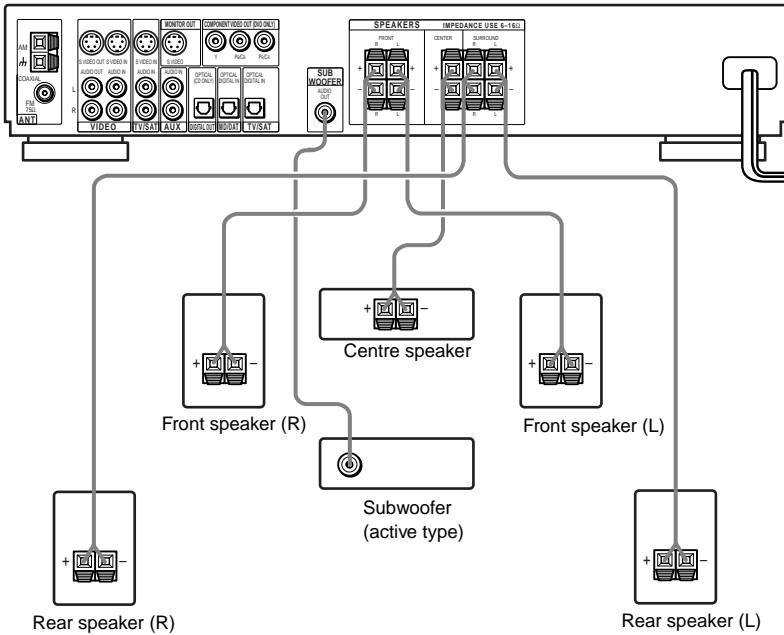

## To avoid short-circuiting the speakers

Short-circuiting of the speakers may damage the receiver. To prevent this, be sure to follow these precautions when connecting the speakers. Make sure the bare wire of each speaker cord does not touch another speaker terminal or the bare wire of another speaker cord.

### Examples of poor conditions of the speaker cord

Stripped speaker cord is touching another speaker terminal.

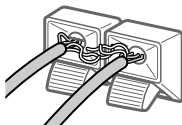

Stripped cords are touching each other due to excessive removal of insulation.

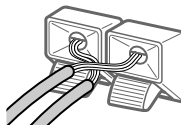

After connecting all the components, speakers, and AC power cord (mains lead), output a test tone to check that all the speakers are connected correctly. For details on outputting a test tone, see page 26.

If no sound is heard from a speaker while outputting a test tone, or a test tone is output from a speaker other than the one currently displayed on the front panel display, the speaker may be short-circuited. If this happens, check the speaker connection again.

### Notes

- Be sure to match the speaker cord to the appropriate terminal on the components:  $\oplus$  to  $\oplus$ , and  $\ominus$  to  $\ominus$ . If the cords are reversed, the sound will be distorted and will lack bass.
- If you use front speakers with low maximum input rating, adjust the volume carefully to avoid excessive output on the speakers.

## Step 2: Antenna Hookups

Connect the supplied AM/FM antennas for listening to the radio.

### Terminals for connecting the antennas

Connect the	To the
AM loop antenna	AM terminals
FM wire antenna	FM 75Ω COAXIAL terminal

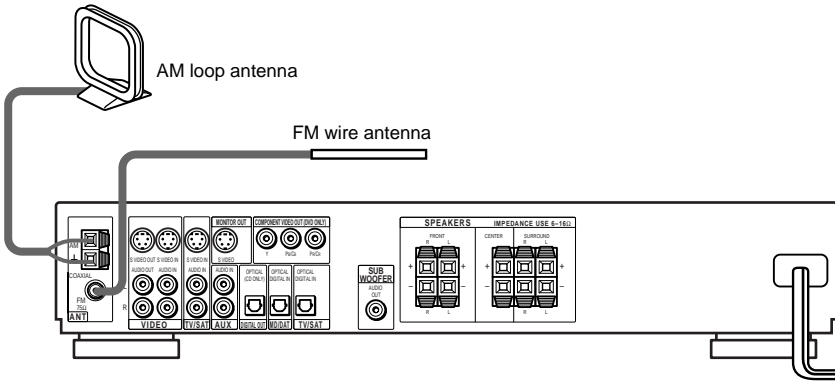

### Notes

- To prevent noise pickup, keep the AM loop antenna away from the receiver and other components.
- Be sure to fully extend the FM wire antenna.
- After connecting the FM wire antenna, keep it as horizontal as possible.

**💡 If you have poor FM reception**

Use a 75-ohms coaxial cable (not supplied) to connect the receiver to an outdoor FM antenna as shown below.

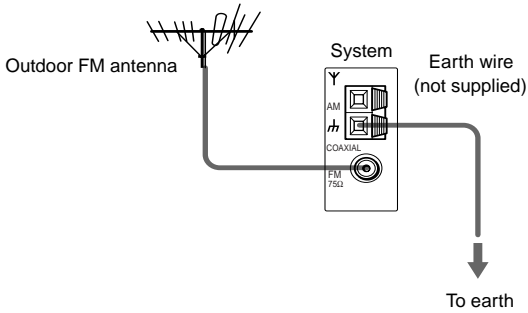

**Note**

If you connect the receiver to an outdoor antenna, ground it to protect against lightning. To prevent a gas explosion, do not connect the earth wire to a gas pipe.

## Step 3: TV and Video Component Hookups

### Required cords

#### S Video cord for connecting a TV monitor



#### Audio cords (not supplied)

When connecting a cord, be sure to match the colour-coded pins to the appropriate jacks on the components.

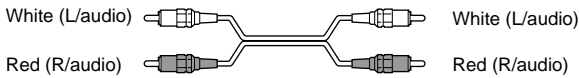

### Jacks for connecting video components

Connect a	To the
TV monitor	MONITOR OUT (S VIDEO) jack
VCR	VIDEO (S VIDEO/AUDIO L/R IN/OUT) jacks
Digital satellite receiver	TV/SAT (S VIDEO/AUDIO L/R IN) jacks

**💡 When using the COMPONENT VIDEO OUT jacks instead of the S Video jacks (Y, P<sub>B</sub>/C<sub>B</sub>, P<sub>R</sub>/C<sub>R</sub>)**  
Your TV monitor must also be connected via COMPONENT VIDEO OUT jacks (Y, P<sub>B</sub>/C<sub>B</sub>, P<sub>R</sub>/C<sub>R</sub>).

### Notes

- When you select VIDEO using the FUNCTION button, the signal is output from the front L/R speakers, but not from the VIDEO (AUDIO L/R OUT) jacks.
- When you use the Video line outputs, please set the unit to 2CH STEREO mode. If the unit is not in 2CH STEREO mode, the line outputs may not function properly.

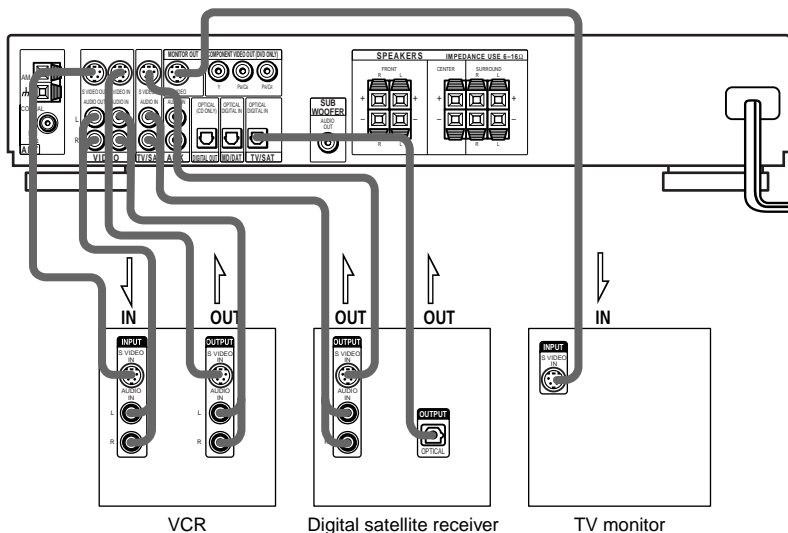

### If you connect a digital satellite receiver with the TV/SAT (OPTICAL DIGITAL IN) jack

The digital satellite receiver can be connected to the TV/SAT (OPTICAL DIGITAL IN) jack instead of the TV/SAT (AUDIO L/R IN) jacks of the system.

The system can accept both the digital and analog signals. Digital signals have priority over analog signals. If the digital signal ceases, the analog signal will be processed after 2 seconds.

### If you connect a digital satellite receiver without the TV/SAT (OPTICAL DIGITAL IN) jack

Connect the digital satellite receiver to the TV/SAT (AUDIO L/R IN) jacks only of the system.

## Setup for the system (for Asian models)

Setup is necessary for the system, depending on the TV monitor to be connected. The initial setting for Asian models is NTSC.

### If the colour system of the TV is PAL\*

To set the system to PAL, turn on the system by pressing **I/⏻** on the remote while pressing **|||** (pause) button on the system. You need to hold the **|||** button until AVD-S10 appears on the display. To reset to NTSC, turn off the system and then turn on again using the remote while pressing the **|||** button on the system.

\* If the colour system of the TV is NTSC, do the same operation above to set the system to NTSC.

## Connecting the AC Power Cord (mains lead)

Before connecting the AC power cord (mains lead) of this system to a wall outlet (mains), connect the speakers to the system (see page 17).

Connect the AC power cord (mains lead) of your TV/video components to a wall outlet (mains).

# Speaker Setup

For the best possible surround sound, all the speakers other than the subwoofer should be the same distance from the listening position (A).

However, this receiver allows you to place the centre speaker up to 1.6 meters (5.0 feet) closer (B) and the rear speakers up to 4.6 meters (15.0 feet) closer (C) to the listening position. The front speakers can be placed from 1.0 to 15.0 meters (3.0 to 50.0 feet) (A) from the listening position.

You can place the subwoofer in any position.

You can place the rear speakers either behind you or to the side, depending on the shape of your room, etc.

When the rear speakers are placed to the side

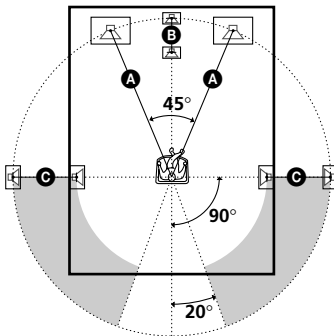

When the rear speakers are placed behind you

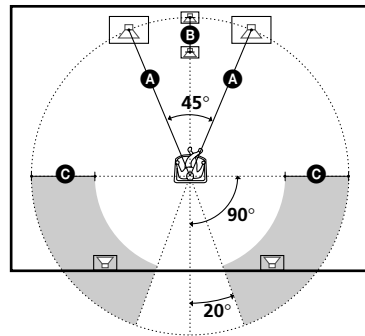

## Note

Do not place the centre and rear speakers farther away from the listening position than the front speakers.

## Specifying the speaker parameters

To obtain the best possible surround sound, first specify the distance of the speakers from your listening position, then set the balance and level. Use the test tone to adjust the speaker volumes to the same level.

You may adjust the speaker parameters using **SPEAKER SETUP** in the setup display (page 67).

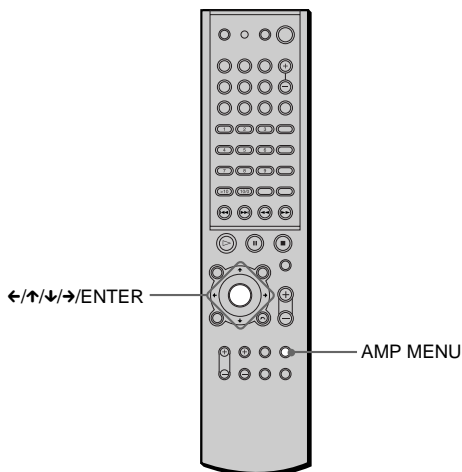

### To specify the size, distance, position and height of the speakers

- 1** Press AMP MENU repeatedly to display **♪ SP. SETUP** on the front panel display.
- 2** Sit in your listening position and select the item to be set using **↑/↓**.
  - Items set in **♪ SP. SETUP**
    - Size of 5 speakers (front L/R, centre, rear L/R)
    - with or without the subwoofer
    - Distance of the front, rear, and centre speakers
    - Position and height of the rear speakers
- 3** Set the parameter using **←/→**.  
The selected parameter will appear on the front panel display.
- 4** Repeat Steps 2 and 3 to set other parameters in **♪ SP. SETUP**.  
If you do not operate the remote for a few seconds, the parameter turns off and is stored in the receiver.

#### ■ SIZE

When you do not connect centre or rear speakers, or move the rear speakers, set the parameters for F.SP., C.SP., R.SP., and S.W. The default settings are underlined.

- F.SP. (front speaker)
  - LARGE: Normally select this.
  - SMALL: Select this if the small speakers are used for the front speaker.
- C.SP. (centre speaker)
  - LARGE: Normally select this.
  - SMALL: Select this if the small speaker is used for the centre speaker.
  - NO: Select this if no centre speaker is used.



- R.SP. (rear speakers)
  - **LARGE**: Normally select this. Specify the position and height to implement the Digital Cinema Surround modes in the “Virtual” sound field (page 48) properly.
  - **SMALL**: Select this if the small speakers are used for the rear speaker. Specify the position and height to implement the Digital Cinema Surround modes in the “Virtual” sound field (page 48) properly.
  - **NO**: Select this if no rear speakers are used.
- S.W. (subwoofer)
  - **YES**: Select this if the subwoofer is used.
  - **NO**: Select this if no subwoofer is used.

## ■ DISTANCE

You can vary the distance of each speaker as follows. The default settings are underlined.

- F. D. 5 m (17 ft) (front speakers distance)  
Front speaker distance can be set in 0.2 meter (1.0 foot) steps from 1.0 to 15.0 meters (3.0 to 50.0 feet).
- C. D. 5 m (17 ft) (centre speaker distance)  
Centre speaker distance can be set in 0.2 meter (1.0 foot) steps from the front speaker distance to 1.6 meters (5.0 feet) closer to your listening position.
- R. D. 3.4 m (12 ft) (rear speakers distance)  
Rear speaker distance can be set in 0.2 meter (1.0 foot) steps from a distance equal to the front speaker distance to a distance 4.6 meters (15.0 feet) closer to your listening position.

## Note

If each of the front or rear speakers are not placed an equal distance from your listening position, set the distance of the closest speaker.

## Specifying the rear speaker position and height

If you select anything other than “NO” in “R.SP.,” specify the position and height of the rear speakers. The default settings are underlined.

Position diagram

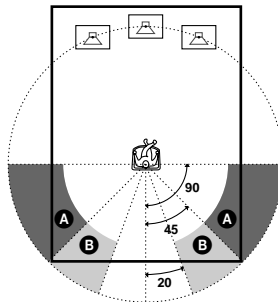

- R. P. BEHIND  
Select this if the rear speakers are located in the section **B**.
- R. P. SIDE  
Select this if the rear speakers are located in the section **A**.

## Height diagram

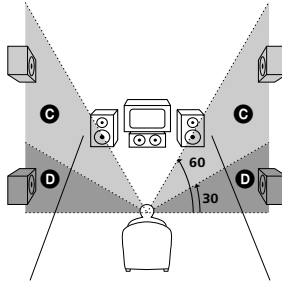

- R. H. LOW  
Select this if the rear speakers are located in section **D**.
- R. H. HIGH  
Select this if the rear speakers are located in section **C**.

These parameters are not available when “R.SP.” is set to “NO”.

### To specify the balance and level of the speakers

- 1 Press AMP MENU repeatedly to display  $\flat$  LEVEL on the front panel display.
- 2 Use  $\uparrow/\downarrow$  to select T.TONE and use  $\leftarrow/\rightarrow$  to set T.TONE to ON.  
You will hear the test tone from each speaker in sequence.
- 3 Sit in your listening position and select the item to be adjusted using  $\uparrow/\downarrow$ .
  - Items adjusted in  $\flat$  LEVEL
    - Balance of the front and rear speakers
    - Volume level of the centre and rear speakers and subwoofer
- 4 Adjust the volume level so that the volume of the test tone from each speaker sounds the same using  $\leftarrow/\rightarrow$ .  
The adjusted value will appear on the front panel display.
- 5 Repeat Steps 3 and 4 to adjust other parameters in  $\flat$  LEVEL.  
If you do not operate the remote for a few seconds, the value disappears from the display and is stored in the receiver.
- 6 Use  $\uparrow/\downarrow$  to select T.TONE and use  $\leftarrow/\rightarrow$  to set T.TONE to OFF.

### ■BALANCE

You can vary the balance of each speaker as follows. The default settings are underlined.

- F. ....I..... centre (front speakers)  
Adjust the balance between the front left and right speakers (You can adjust from centre, 6 steps left or right).
- R. ....I..... centre (rear speakers)  
Adjust the balance between the rear left and right speakers (You can adjust from centre, 6 steps left or right).

**■ LEVEL**

You can vary the level of each speaker as follows. The default settings are underlined.

- C. LEVEL 0 dB (centre speaker level)  
Adjust the level of the centre speaker (you can adjust from -10 dB to +10 dB in 1 dB steps).
- R. LEVEL 0 dB (rear speakers level)  
Adjust the level of the rear speakers (you can adjust from -10 dB to +10 dB in 1 dB steps).
- SW. LEV. 0 dB (subwoofer level)  
Adjust the level of the subwoofer (you can adjust from -10 dB to +10 dB in 1 dB steps).

**Notes**

- When you select an item, the sound cuts off for a moment.
- Depending on the settings of other speakers, the subwoofer may output excessive sound.

**To adjust the volume of all the speakers at one time**

Use the VOLUME control.

**Other AMP MENU settings**

You can control the brightness of the front panel display, clear the preset stations and the station names, and set the speaker parameters back to the default setting. Press AMP MENU repeatedly to display  $\downarrow$  CUSTOMIZE. Use  $\uparrow/\downarrow$  to select the following items.

**■ DIMMER**

You can change the brightness of the front panel display by two ways. Use  $\leftarrow/\rightarrow$  to adjust the settings or press DIMMER.

**■ MEMO. CLR.**

You can clear the preset stations and station names, and set the speaker parameters back to the default setting.

- MEMO.CLR.N (No): Press ENTER to skip back to previous menu.
- MEMO.CLR.Y (Yes): If you press ENTER, “Really? N” appears. To clear the memory, use  $\leftarrow/\rightarrow$  to select “Really? Y” and press ENTER. “ALL CLEAR!” is displayed and all settings such as preset stations and station names will be cleared, and speaker parameters will be reset to their default settings.

# Presetting Radio Stations

You can preset 20 stations for FM and 10 stations for AM.  
Before tuning, make sure to turn down the volume to minimum.

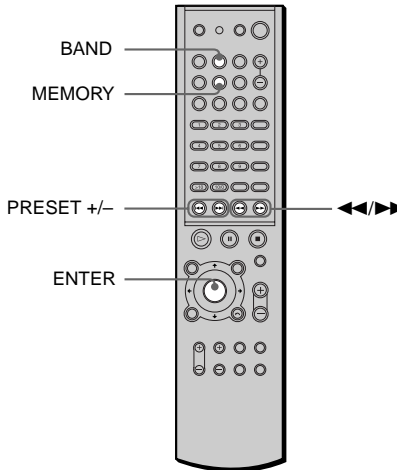

- 1 Press BAND repeatedly until the band you want appears on the front panel display.**

Every time you press BAND, the band changes to AM or FM alternately.

- 2 Press and hold ◀◀ or ▶▶ until the frequency indication starts to change, then release.**

Scanning stops when the receiver tunes in a station. “TUNED” and “ST” (for stereo programme) appear on the front panel display.



- 3 Press MEMORY.**

A preset number appears on the front panel display.



- 4 Press PRESET + or - to select the preset number you want.**

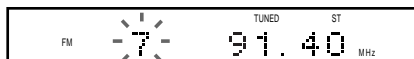

**5 Press ENTER.**

The station is stored.

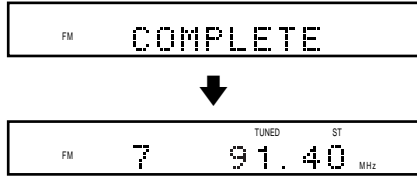
**6 Repeat 1 to 5 to store other stations.****To tune in a station with a weak signal**



Press ◀ or ▶ repeatedly in 2 to tune in the station manually.

**To change the preset number**

Start over from 1.

**To change the AM tuning interval (except for European, Middle Eastern, and Philippine models)**

The AM tuning interval is factory set to 9 kHz (10 kHz in some areas).

To change the AM tuning interval, tune in any AM station first, then turn off the system by pressing  on the remote. While holding down  (on the system), turn on the power using the remote. When you change the interval, AM preset stations will be erased.

To reset the interval, repeat the same procedure.

# Playing Discs



Depending on the DVD or VIDEO CD, some operations may be different or restricted.

Refer to the operating instructions supplied with your disc.

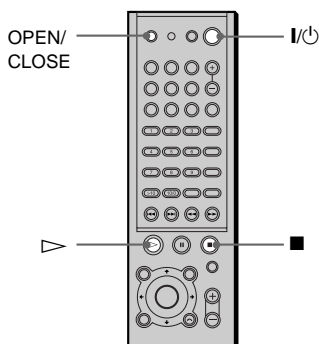
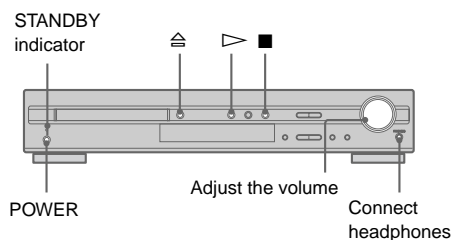

- 1 Turn on your TV.**
- 2 Switch the input selector on the TV to this receiver.**
- 3 Press POWER on the receiver.**  
The receiver enters standby mode and the STANDBY indicator lights up in red.

- 4 Press  $\triangle$  on the receiver or OPEN/CLOSE on the remote, and place a disc on the disc tray.**

The receiver automatically turns on and the STANDBY indicator turns off.

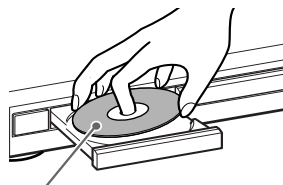

With the playback side facing down

- 5 Press  $\triangleright$ .**  
The disc tray closes, and the receiver starts playback (continuous play). Adjust the volume on the receiver.

## After following Step 5

Depending on the disc, a menu may appear on the TV screen. You can play the disc interactively by following the instructions on the menu. DVD (page 32), VIDEO CD (page 33).

## To turn on the receiver

Press POWER on the receiver. The receiver enters standby mode and the STANDBY indicator lights up in red. Press I/O on the remote. The receiver turns on and the STANDBY indicator turns off. In standby mode, you can also turn on the receiver by pressing  $\triangle$  on the receiver or by pressing  $\triangleright$ .

## To turn off the receiver

Press I/O on the remote. The receiver enters standby mode and the STANDBY indicator lights up in red. To turn off the receiver completely, press POWER on the receiver. While playing a disc, do not turn off the receiver by pressing POWER. Doing so may cancel the menu settings. When you turn off the receiver, first press ■ to stop playback and then press I/O on the remote.

## Saving the power in standby mode

Press on the remote once.

While the receiver is in standby mode, the STANDBY indicator on the receiver lights up.

## To cancel standby mode

Press on the remote once.

## Additional operations

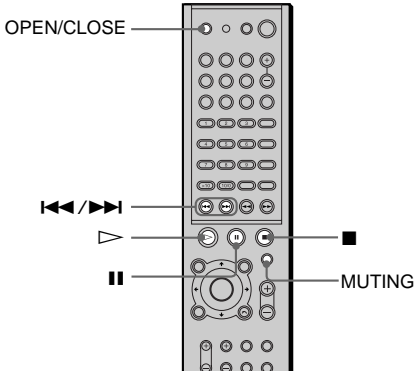

To	Operation
Stop	Press .
Pause	Press .
Resume play after pause	Press  or .
Go to the next chapter, track, or scene in continuous play mode	Press .
Go back to the preceding chapter, track, or scene in continuous play mode	Press .
Stop play and remove the disc	Press OPEN/CLOSE.
Mute the sound	Press MUTING. To cancel muting, press it again or turn up the volume.

### Note

Do not push the disc tray when closing it. Press OPEN/CLOSE to close the disc tray.

## Resuming Playback from the Point Where You Stopped the Disc (Resume Play)



When you stop the disc, the receiver remembers the point where you pressed and “RESUME” appears on the front panel display. As long as you do not open the disc tray, Resume Play will work even if the receiver enters standby mode by pressing .

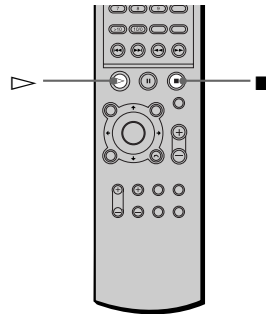

- 1 While playing a disc, press to stop playback.**  
“RESUME” appears on the front panel display, so you can restart the disc from the point where you stopped the disc.  
If “RESUME” does not appear, Resume Play is not available.

- 2 Press .**  
The receiver starts playback from the point where you stopped the disc in Step 1.

To play from the beginning of the disc, press twice, then press .

## Notes

- Depending on where you stopped the disc, the receiver may not resume playback from exactly the same point.
- The point where you stopped playing is cleared when:
  - you turn the power off by pressing POWER on the receiver.
  - you change the play mode.

## Using the DVD's Menu

### DVD

A DVD is divided into long sections of a picture or a music feature called “titles.” When you play a DVD which contains several titles, you can select the title you want using DVD TOP MENU.

When you play DVDs that allow you to select items such as the language for the subtitles and the language for the sound, select these items using DVD MENU.

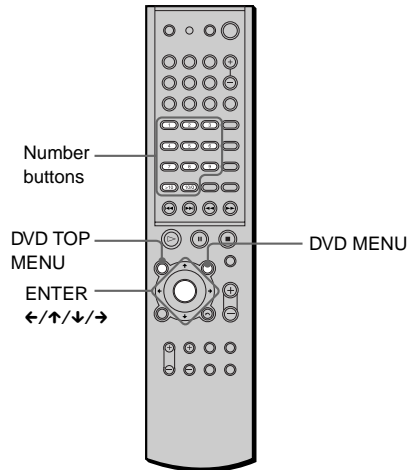

---

### 1 Press DVD TOP MENU or DVD MENU.

The disc's menu appears on the TV screen.

The contents of the menu vary from disc to disc.

---

### 2 Press ←/↑/↓/→ or the number buttons to select the item you want to play or change.

---

### 3 Press ENTER.

---



## Playing VIDEO CDs with PBC Functions (PBC Playback)

VIDEO CD

With PBC (Playback Control) functions, you can enjoy simple interactive operations, search functions, and other such operations. PBC playback allows you to play VIDEO CDs interactively by following the menu on the TV screen.

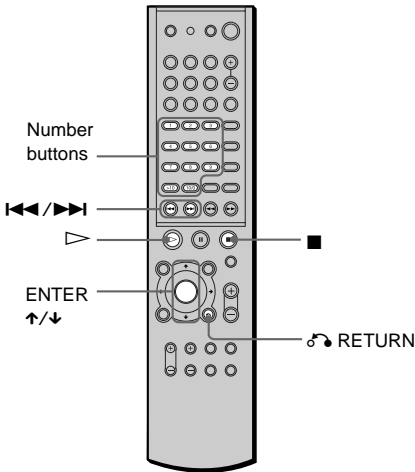

### To go back to the menu

Press RETURN.

To play without using PBC, press or the number buttons while the receiver is stopped to select a track, then press or ENTER.

“Play without PBC” appears on the TV screen and the receiver starts continuous play. You cannot play still pictures such as a menu. To return to PBC playback, press twice, then press .

### Note

Depending on the VIDEO CD, “Press ENTER” in Step 3 may appear as “Press SELECT” in the instructions supplied with the disc. In this case, press .

### 1 Start playing a VIDEO CD with PBC functions.

The menu for your selection appears.

### 2 Select the item number you want by pressing or the number buttons.

### 3 Press ENTER.

### 4 Follow the instructions in the menu for interactive operations.

Refer to the instructions supplied with the disc, as the operating procedure may differ according to the VIDEO CD.

# Creating Your Own Programme (Programme Play)



You can play the contents of a disc in the order you want by arranging the order of the titles, chapters or tracks on the disc to create your own programme. You can programme up to 25 titles, chapters, and tracks.

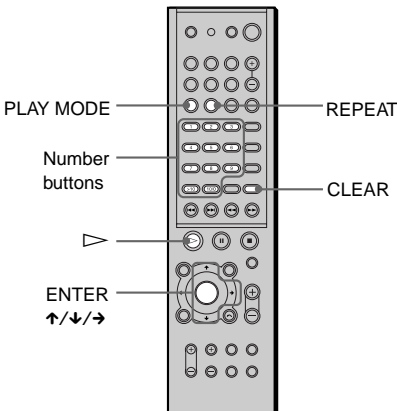

## 1 In stop mode, press **PLAY MODE** repeatedly until **"PROGRAM"** appears on the front panel display.

The programming display appears on the TV screen.

"TRACK" is displayed when you play a VIDEO CD, Super Audio CD, or CD.

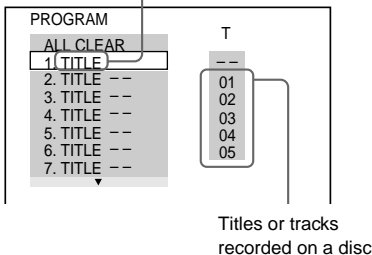

## 2 Press **→**.

The cursor moves to the title or track (in this case, "01").

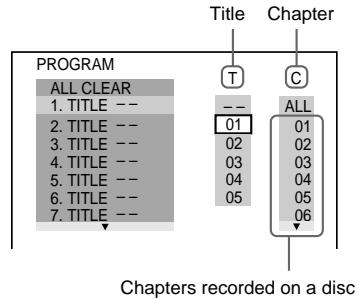

## 3 Select the title, chapter, or track you want to programme.

### ■ When playing a DVD

For example, select chapter "03" of title "02."

Press **↑/↓** or the number buttons to select "02" under "T," then press **ENTER**.

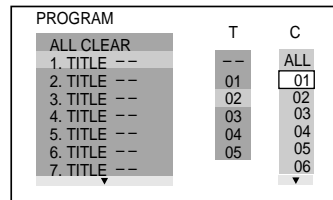

Next, press **↑/↓** or the number buttons to select "03" under "C," then press **ENTER**.

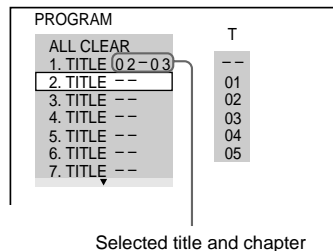

## ■ When playing a VIDEO CD, Super Audio CD, or CD

For example, select track "02."

Press  $\uparrow/\downarrow$  or the number buttons to select "02" under "T," then press ENTER.

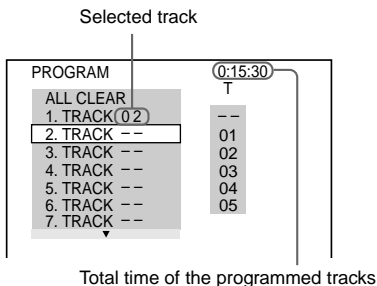

## To cancel the programmed order

To cancel all the titles, chapters, or tracks in the programmed order, press  $\uparrow$ , and select "ALL CLEAR" in Step 2. To cancel the selected programme, select the programme using  $\uparrow/\downarrow$  in Step 2, then press CLEAR, or select "--" in Step 3, then press ENTER.

You can do Repeat Play of the programmed titles, chapters, or tracks. Press REPEAT, or set "REPEAT" to "ON" in the Control Menu display during Programme Play.

### Note

The number of titles, chapters, or tracks displayed are the same number of titles, chapters, or tracks recorded on a disc.

## 4 To programme other titles, chapters, or tracks, repeat Steps 2 to 3.

The programmed titles, chapters, and tracks are displayed in the selected order.

## 5 Press $\triangleright$ to start Programme Play.

Programme Play begins.

When the programme ends, you can restart the same programme again by pressing  $\triangleright$ .

## To return to normal play

Press CLEAR during playback.

## To turn off the programme menu

In stop mode, press PLAY MODE to turn off the programme menu.

## To change the programme

**1** In Step 2, select the programme number of the title, chapter, or track you want to change using  $\uparrow/\downarrow$  or the number buttons, and press  $\rightarrow$ .

**2** Follow Step 3 for new programming.

## Playing in random order

(Shuffle Play)   

You can have the receiver “shuffle” titles, chapters, or tracks and play them in random order. Subsequent “shuffling” may produce a different playing order.

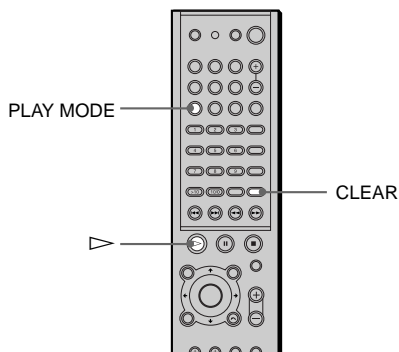

**1** In stop mode, press **PLAY MODE** repeatedly until “SHUFFLE” appears on the front panel display.

**2** Press .

### To return to normal play

In stop mode, press **PLAY MODE** twice, or during playback, press **CLEAR** to return to normal play.

#### Notes

- Shuffle Play is cancelled when:
  - you open or close the disc tray
  - you turn the power off
  - you change the function
- You may not be able to do Shuffle Play depending on the DVD.

## Playing repeatedly (Repeat Play)

  

You can play all the titles/tracks or a single title/chapter/track on a disc.

In Shuffle or Programme Play mode, the receiver repeats the titles or tracks in the shuffled or programmed order.

You cannot perform Repeat Play during PBC playback of VIDEO CDs (page 33).

You may not be able to perform Repeat Play depending on the DVD.

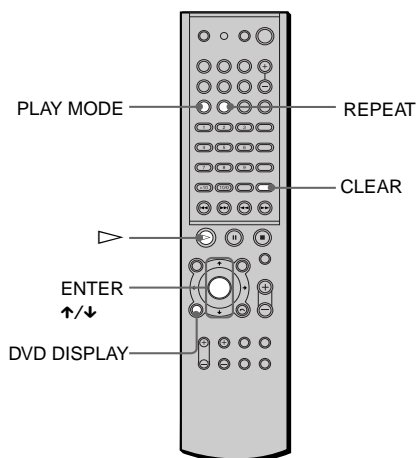

**1** Press **DVD DISPLAY**.

The Control Menu appears.

**2** Press  to select **(REPEAT)**, then press **ENTER**.

If you do not select “OFF,” the indicator of “REPEAT” lights up in green.

### 3 Select the Repeat Play setting.

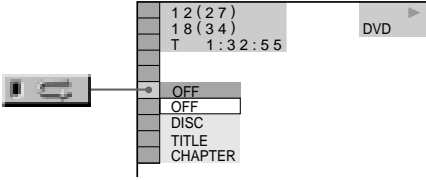

#### When playing a DVD and when Programme Play is set to OFF

- **OFF**: does not play repeatedly.
- **DISC**: repeats all the titles.
- **TITLE**: repeats the current title on a disc.
- **CHAPTER**: repeats the current chapter.

#### When playing a VIDEO CD/Super Audio CD/CD and when Programme Play is set to OFF

- **OFF**: does not play repeatedly.
- **DISC**: repeats all the tracks on a disc.
- **TRACK**: repeats the current track

#### When Programme Play is set to ON

- **OFF**: does not play repeatedly.
- **ON**: repeats Programme Play.

#### To cancel Repeat Play

Press CLEAR.

#### You can set Repeat Play during stop mode

After selecting the “REPEAT” item, press  $\triangleright$ .  
The receiver starts Repeat Play.

#### You can quickly display the “REPEAT” status

Press REPEAT on the remote.

#### **Note**

Repeat play is cancelled when:

- you turn the power off.
- you change the function.

## Searching for a Particular Point on a Disc (Scan, Slow-motion Play)

(DVD) (VIDEO CD) (SA-CD)

You can locate a particular point on a disc quickly by monitoring the picture or playing back slowly.

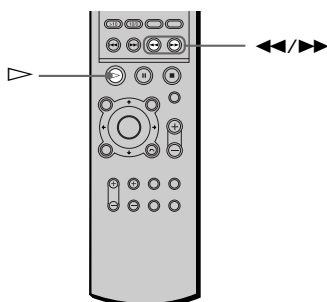

### Note

Depending on the DVD/VIDEO CD, you may not be able to do some of the operations described.

## Locating a point quickly by playing a disc in fast forward or fast reverse (Scan)

Press  $\lll$  or  $\ggg$  while playing a disc. When you find the point you want, press  $\triangleleft$  to return to normal speed. Each time you press  $\lll$  or  $\ggg$  during scan, the playback speed changes. Three speeds are available. With each press, the indication changes as follows:

Playback direction

$\times 2 \ggg$  (DVD/Super Audio CD/CD only)  $\rightarrow$  FF1  $\ggg$   
 $\uparrow$   $\text{FF2} \ggg \leftarrow$

Opposite direction

$\times 2 \lll$  (DVD only)  $\rightarrow$  FR1  $\lll \rightarrow$  FR2  $\lll$   
 $\uparrow$   $\text{FR2} \lll \leftarrow$

The  $\times 2 \ggg / \times 2 \lll$  playback speed is about twice the normal speed. The FF2  $\ggg$  / FR2  $\lll$  playback speed is faster than FF1  $\ggg$  / FR1  $\lll$ .

## Watching frame by frame (Slow-motion play) (DVD) (VIDEO CD)

You can use this function only for DVDs or VIDEO CDs. Press  $\lll$  or  $\ggg$  when the receiver is in the pause mode. To return to normal speed, press  $\triangleleft$ .

Each time you press  $\lll$  or  $\ggg$  during Slow-motion play, the playback speed changes. Two speeds are available. With each press, the indication changes as follows:

Playback direction

SLOW 2  $\ggg \leftrightarrow$  SLOW 1  $\ggg$

Opposite direction (DVD only)

SLOW 2  $\lll \leftrightarrow$  SLOW 1  $\lll$

The SLOW 2  $\ggg$  / SLOW 2  $\lll$  playback speed is slower than SLOW 1  $\ggg$  / SLOW 1  $\lll$ .

# Searching for a Title/ Chapter/Track/Index/ Scene



You can search a DVD disc by title or chapter, and you can search a VIDEO CD or CD by track, index, or scene. As titles and tracks are assigned unique numbers on the disc, you can select the desired one by entering its number. Or, you can search for a scene using the time code. (TIME SEARCH)

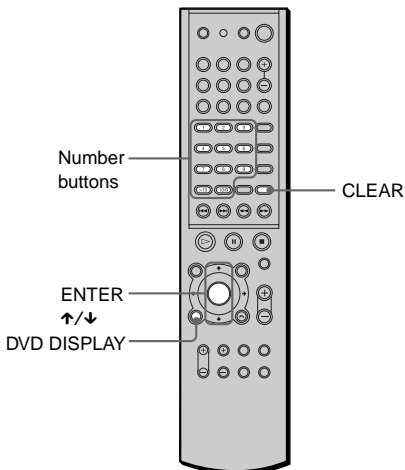

**1 Press DVD DISPLAY.**  
The Control Menu appears.

**2 Press ↑/↓ to select the search method.**

■ When playing a DVD

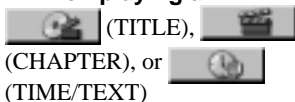

Select TIME/TEXT for TIME SEARCH.

■ When playing a VIDEO CD

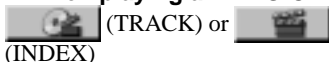

■ When playing a VIDEO CD with PBC Playback



■ When playing a Super Audio CD/CD



Example: when you select (CHAPTER)

“\*\* (\*\*)” is selected (\*\* refers to a number).

The number in parentheses indicates the total number of titles, chapters, tracks, indexes, or scenes.

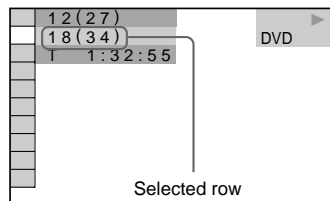

**3 Press ENTER.**  
“\*\* (\*\*)” changes to “— (\*\*)”.

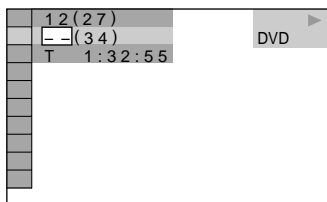

**4 Press ↑/↓ or the number buttons to select the title, chapter, track, index, or scene number you want to search.**

**If you make a mistake**

Cancel the number by pressing CLEAR, then select another number.

---

## 5 Press ENTER.

The receiver starts playback from the selected number.

---

### To turn off the Control Menu

Press DVD DISPLAY repeatedly until the Control Menu is turned off.

### To search for a scene using the time code (TIME SEARCH) (DVD only)

- 1 In Step 2, select  (TIME/TEXT).  
“T \*\*:\*\*\*:\*\*\*” (playing time of the current title) is selected.
- 2 Press ENTER.  
“T \*\*:\*\*\*:\*\*\*” changes to “T --:--:--.”
- 3 Input the time code using the number buttons, then press ENTER.  
For example, to find the scene at 2 hours, 10 minutes, and 20 seconds after the beginning, just enter “2:10:20.”

#### **Note**

The title, chapter or track number displayed is the same number recorded on the disc.



## Viewing the Playing Time and Remaining Time on the Front Panel Display



You can check information about the disc, such as the remaining time, total number of titles of a DVD, or tracks of a Super Audio CD, CD, or VIDEO CD, using the front panel display (page 10).

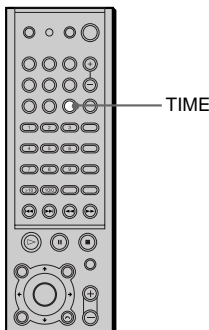

### Press TIME.

Each time you press TIME while playing the disc, the display changes as shown in the following charts.

### When playing a DVD

Playing time and number of the current title

TITLE	CHAPTER	H	M	S
1	2	10	3	24

Remaining time of the current title

TITLE	CHAPTER	H	M	S
1	2	-11	5	36

Playing time and number of the current chapter

CHAPTER	H	M	S
2	0	2	30

Remaining time of the current chapter

CHAPTER	H	M	S
2	-0	1	320

Text

SONY HITS/
------------

### When playing a VIDEO CD (without PBC functions), Super Audio CD, or CD

Playing time and current track number

TRACK	INDEX	M	S
2	1	2	25

Remaining time of the current track

TRACK	INDEX	M	S
2	1	-1	50

Playing time of the disc

M	S
3	212

Remaining time of the disc

M	S
-2	018

Text

SONY HITS/
------------

💡 When playing VIDEO CDs with PBC functions, the scene number and the playing time are displayed.

💡 The playing time and remaining time of the current chapter, title, track, scene, or disc will also appear on your TV screen. See the following section “Checking the Playing Time and Remaining Time” for instructions on how to read this information.

### Notes

- While playing Super Audio CD, the index indicator does not appear on the front panel display.
- Depending on the type of disc being played and the playing mode, the disc information may not be displayed.

## Checking the Playing Time and Remaining Time



You can check the playing time and remaining time of the current title, chapter, or track, and the total playing time or remaining time of the disc. You can also check the DVD/CD/Super Audio CD text recorded on the disc.

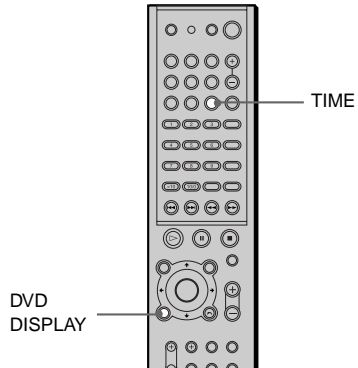

### 1 Press DVD DISPLAY during playback.

The Control Menu appears.

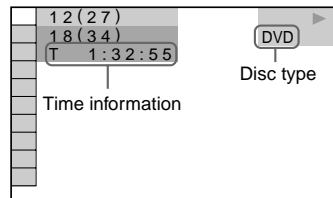

## 2 Press TIME repeatedly to change the time information.

The display and the kinds of time that you can change depend on the disc you are playing.

### ■ When playing a DVD

- T \*\*:\*\*:\*\*  
Playing time of the current title
- T-\*\*:\*\*:\*\*  
Remaining time of the current title
- C \*\*:\*\*:\*\*  
Playing time of the current chapter
- C-\*\*:\*\*:\*\*  
Remaining time of the current chapter

### ■ When playing a VIDEO CD (with PBC functions)

- \*\*:\*\*:\*\*  
Playing time of the current scene

### ■ When playing a VIDEO CD (without PBC functions), Super Audio CD, or CD

- T \*\*:\*\*:\*\*  
Playing time of the current track
- T-\*\*:\*\*:\*\*  
Remaining time of the current track
- D \*\*:\*\*:\*\*  
Playing time of the current disc
- D-\*\*:\*\*:\*\*  
Remaining time of the current disc

## To turn off the Control Menu

Press DVD DISPLAY repeatedly until the Control Menu is turned off.

## Checking the DVD/CD/Super Audio CD text

Press TIME repeatedly in Step 2 to display the text recorded on the DVD/CD/Super Audio CD. The DVD/CD/Super Audio CD text appears only when the text is recorded on the disc. You cannot change the text.

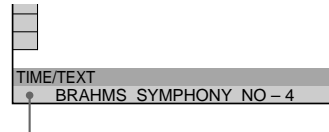

DVD/CD/Super Audio CD text

💡 If the DVD/CD/Super Audio CD text does not fit in a single line, you can see the entire text scrolls across the front display.

💡 You can select the time and text by pressing TIME.

### Notes

- Only English words can be displayed.
- In Super Audio CD playback, the receiver can only display a limited number of characters. Also, depending on the disc, not all text characters are not displayed.

## Changing the Sound



If a DVD is recorded with multilingual tracks, you can select the language you want while playing the DVD.

If the DVD is recorded in multiple audio formats (PCM, Dolby Digital, MPEG audio, or DTS), you can select the audio format you want while playing the DVD.

With stereo CDs or VIDEO CDs, you can select the sound from the right or left channel and listen to the sound of the selected channel through both the right and left speakers. (In this case, the sound loses its stereo effect.)

For example, when playing a disc containing a song with the vocals on the right channel and the instruments on the left channel, you can select the left channel and hear only the instruments from both speakers.

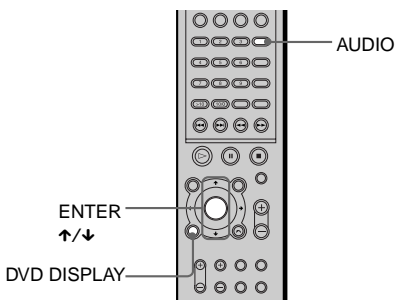

### 1 Press DVD DISPLAY during playback.

The Control Menu is displayed.

### 2 Press $\uparrow/\downarrow$ to select (AUDIO), then press ENTER.

The options for AUDIO appear.

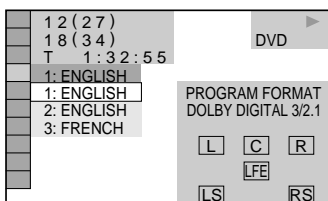

### 3 Press $\uparrow/\downarrow$ to select the desired audio signal.

#### ■ When playing a DVD

Depending on the DVD, the choice of language varies.

When 4 digits are displayed, they represent the language code. Refer to the language code list on page 79 to see which language the code represents. When the same language is displayed two or more times, the DVD is recorded in multiple audio formats.

#### ■ When playing a VIDEO CD, or CD

The default setting is underlined.

- STEREO: The standard stereo sound
- 1/L: The sound of the left channel (monaural)
- 2/R: The sound of the right channel (monaural)

#### ■ When playing a Super Audio CD

In stop mode, depending on the Super Audio CD, the choice of settings varies.

- MULTI: The disc has multi-channel playback area
- 2CH: The disc has the 2 channel playback area.
- CD: When you want to play the disc as a conventional CD.

#### Note

Not all discs give you the three choices above when in Super Audio CD playback. It all depends on the layer configuration of the Super Audio CD to be played.

### 4 Press ENTER.

#### To turn off the Control Menu

Press DVD DISPLAY repeatedly until the Control Menu is turned off.

You can select AUDIO directly by pressing AUDIO. Each time you press the button, the item changes.

#### Note

For discs not in multiple audio format, you cannot change the sound.

## Displaying the audio information of the disc

When you select “AUDIO,” the channels being played are displayed on the screen. For example, in Dolby Digital format, multiple signals ranging from monaural to 5.1 channel signals can be recorded on a DVD. Depending on the DVD, the number of recorded channels may differ.

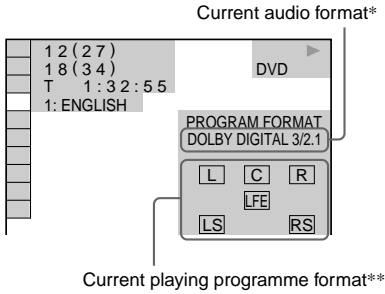

\*“PCM,” “MPEG,” “DTS,” or “DOLBY DIGITAL” is displayed. For “DOLBY DIGITAL,” the channels in the playing track are displayed numerically as follows:

For Dolby Digital 5.1 ch:

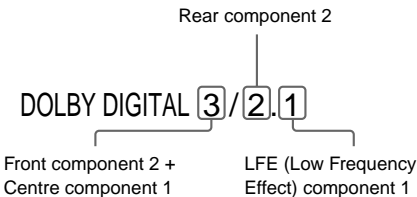

\*\*The letters in the programme format display mean the following sound component:

- L: Front (left)
- R : Front (right)
- C : Centre
- LS : Rear (left)
- RS : Rear (right)
- S : Rear (monaural): The rear component of the Dolby Surround processed signal and the Dolby Digital signal.
- LFE : LFE (Low Frequency Effect)

The display examples are as follows:

- PCM (stereo)

PROGRAM FORMAT  
PCM 48kHz 24bit

- Dolby Surround

PROGRAM FORMAT  
DOLBY DIGITAL 2/0  
DOLBY SURROUND  
L C R  
S

- Dolby Digital 5.1 ch

When an LFE signal component is output, “LFE” is enclosed in a solid line. When an LFE signal component is not output, “LFE” is enclosed in a broken line.

PROGRAM FORMAT  
DOLBY DIGITAL 3/2.1  
L C R  
LFE  
LS RS

- DTS

“LFE” is always enclosed in a solid line regardless of the LFE signal component being output.

PROGRAM FORMAT  
DTS 3/2.1  
L C R  
LFE  
LS RS

### Notes

- When the signal contains rear signal components such as LS, RS, or S, the surround effect is enhanced (page 46).
- If you play MPEG AUDIO sound tracks, the receiver outputs PCM (stereo) signals.

## Automatically decoding the input audio signal (Auto Format Decode)



The auto format decode function automatically detects the type of audio signal being input (Dolby Digital, DTS, or standard 2 channel stereo) and performs the proper decoding if necessary. This mode presents the sound as it was recorded/encoded, without adding any effects (e.g. reverberation).

However, if there are no low frequency signals (Dolby Digital LFE, etc.), it will generate a low frequency signal for output to the sub woofer.

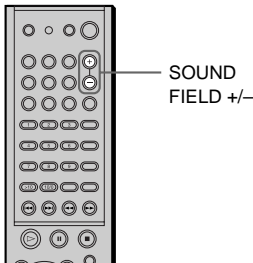

**Press SOUND FIELD +/- repeatedly until “A.F.D.(AUTO FORMAT DECODE)” appears on the front panel display.**

The auto format decode function is activated.

## Enjoying Surround Sound



You can take advantage of surround sound simply by selecting one of the receiver’s pre-programmed sound fields. They bring the exciting and powerful sound of movie theaters and concert halls into your home. To select the sound field, press SOUND FIELD +/- repeatedly until the sound field you want appears on the front panel display.

Sound field	Display
Normal surround	N.SURROUND
Cinema Studio EX A	C.S.EX.A*
Cinema Studio EX B	C.S.EX.B*
Cinema Studio EX C	C.S.EX.C*
Virtual Multi Dimension	V.MULTI D.
Virtual Semi Multi Dimension	V.S.M.D.
Small Hall	SMALL HALL
Large Hall	LARGE HALL
Jazz Club	JAZZ CLUB
Live House	LIVE HOUSE
Game	GAME

\* Use DCS Technology

### About DCS (Digital Cinema Sound)

In the collaboration with Sony Pictures Entertainment, Sony measured the sound environment of their studios and integrated the data of the measurement and Sony’s own DSP (Digital Signal Processor) technology to develop “Digital Cinema Sound”.

“Digital Cinema Sound” simulates in a home theater an ideal movie theater sound environment based on the preference of movie director.

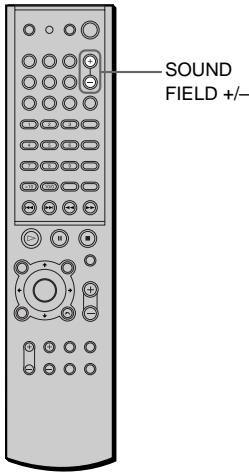

## Enjoying movies with Cinema Studio EX

Cinema Studio EX is ideal for enjoying the movie software encoded with multi channel format, such as the Dolby Digital DVD. This mode reproduces the sound characteristics of Sony Pictures Entertainment's studios.

**Press SOUND FIELD +/- repeatedly until "C.S.EX A (or B, C)" appears on the front panel display.**

### C.S.EX A (Cinema Studio EX A)

Reproduces the sound characteristics of the Sony Pictures Entertainment "Cary Grant Theater" cinema production studio. This is a standard mode, great for watching most any type of movie.

### C.S.EX B (Cinema Studio EX B)

Reproduces the sound characteristics of the Sony Pictures Entertainment "Kim Novak Theater" cinema production studio. This mode is ideal for watching science-fiction or action movies with lots of sound effects.

### C.S.EX C (Cinema Studio EX C)

Reproduces the sound characteristics of the Sony Pictures Entertainment scoring stage. This mode is ideal for watching musicals or classic films where music is featured in the soundtrack.

### About Cinema Studio EX

Cinema Studio EX consists of the following three elements.

- **Virtual Multi Dimension**  
Creates 5 sets of virtual speakers surrounding the listener from a single pair of actual rear speakers.
- **Screen Depth Matching**  
In a movie theater, sound seems to come from inside the image reflected on the movie screen. This element creates the same sensation in your listening room by shifting the sound of the front speakers "into" the screen.
- **Cinema Studio Reverberation**  
Reproduces the reverberations peculiar to a movie theater.

Cinema Studio EX is the integrated mode which operates these elements simultaneously.

### Notes

- The effects provided by the virtual speakers may cause increased noise in the playback signal.
- When listening with sound fields that employ the virtual speakers, you will not be able to hear any sound coming directly from the rear speakers.

### Selecting other sound fields

**Press SOUND FIELD +/- repeatedly until the sound field you want appears on the front panel display.**

The current sound field appears on the front panel display.

## N. SURROUND (Normal Surround)

Software with multi channel surround audio signals is played back according to the way it was recorded. Software with 2 channel audio signals is decoded with Dolby Pro Logic to create surround effects.

## V. MULTI D.\*

### (Virtual Multi Dimension)

Uses 3D sound imaging to create an array of virtual rear speakers positioned higher than the listener from a single pair of actual rear speakers. This mode creates 5 sets of virtual speakers surrounding the listener at approximately a 30° angle of elevation.

SIDE

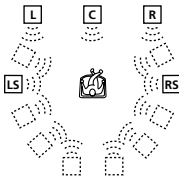

BEHIND

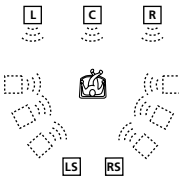

## V. S. M. D.\*

### (Virtual Semi Multi Dimension)

Uses 3D sound imaging to create virtual rear speakers from the sound of the front speakers without using actual rear speakers. This mode creates 5 sets of virtual speakers surrounding the listener at a 30° angle of elevation.

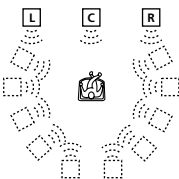

## SMALL HALL (Small Hall)

Reproduces the acoustics of a small rectangular concert hall.

## LARGE HALL (Large Hall)

Reproduces the acoustics of a large rectangular concert hall.  
Ideal for soft acoustic sounds.

## JAZZ CLUB (Jazz Club)

Reproduces the acoustics of a jazz club.

## LIVE HOUSE (Live House)

Reproduces the acoustics of a 300-seat live concert.

## GAME (Game)

Obtains maximum audio impact from video game software.

## HEADPHONE THEATER (Headphone Theatre)

When you connect your headphone to the PHONES jack of the receiver, the HEADPHONE THEATER mode allows you to experience a theatre like environment while listening through a pair of headphones. This mode is very effective with 5.1 ch discreet signal sources like Dolby Digital and DTS. Selecting any Sound Field selections (except AUTO FORMAT DECODE or 2 CH STEREO) enables the mode.

\*“Virtual” sound field: Sound field with virtual speakers.



**To turn the surround effect off**

Press SOUND FIELD +/- repeatedly until "A.F.D." or "2CH STEREO" appears on the front panel display.

**💡 The receiver memorises the last sound field selected for each function mode (Sound Field Link)**

Whenever you select a function such as DVD or TUNER, the sound field that was last applied to the function is automatically applied again. For example, if you listen to DVD with SMALL HALL as the sound field, then change to another function, and then return to DVD, SMALL HALL will be applied again. With the tuner, sound fields are memorised separately for all preset stations.

**💡 You can identify the encoding format of programme software by looking at its packaging**

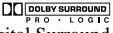
- Dolby Digital discs are labelled with the  logo.
- Dolby Surround encoded programmes are labelled with the  logo.
- DTS Digital Surround discs are marked with DTS.

**Note**

When sound signals with a sampling frequency of 96 kHz are input, the sound signals are output in stereo automatically, and the sound field is turned off.

**Adjustable parameters**

	FRONT BAL.	REAR BAL.	REAR LEVEL	CENTER LEVEL	SUBWOOFER LEVEL
C.S.EX A	●	●	●	●	●
C.S.EX B	●	●	●	●	●
C.S.EX C	●	●	●	●	●
N. SURROUND	●	●	●	●	●
V.MULTI D.	●	●	●	●	●
V.S.M.D.	●			●	●
SMALL HALL	●	●	●	●	●
LARGE HALL	●	●	●	●	●
JAZZ CLUB	●	●	●	●	●
LIVE HOUSE	●	●	●	●	●
GAME	●	●	●	●	●
HEADPHONE THEATER	●				

**Note**

Depending on the disc, the audio signal may not output according to the table above. For details, see the instruction manual of the disc.

---

## Using only the front speakers (2 Channel Stereo)

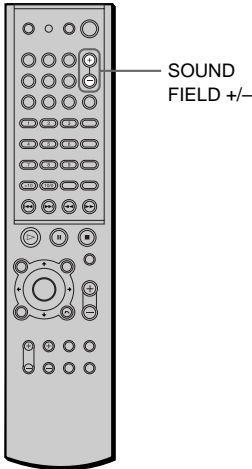

---

**Press SOUND FIELD +/- repeatedly until “2CH STEREO” appears on the front panel display.**

This mode outputs the sound from the front left and right speakers only. Standard 2 channel (stereo) sources completely bypass the sound field processing. Multi channel surround formats are downmixed to 2 channel.

---

### Note

No sound is output from the sub woofer when “2CH STEREO” is selected. To listen to 2 channel (stereo) sources using the front left and right speakers and a sub woofer, press SOUND FIELD +/- repeatedly to select “A.F.D.”

---

## Adjusting the level parameters



The level menu contains parameters that let you adjust the balance and speaker volumes of each speaker (page 26).

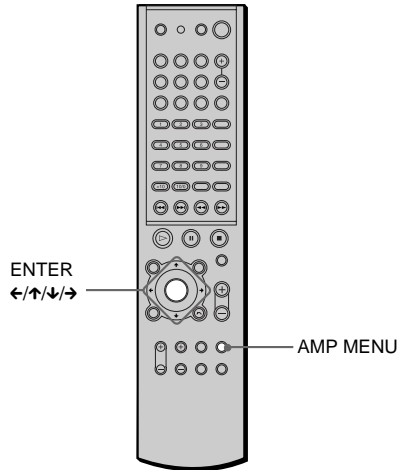

---

**1 Start playing a programme source encoded with multichannel surround sound.**

---

**2 Press AMP MENU repeatedly.**  
‡ LEVEL appears on the front panel display.

---

**3 Sit in your listening position and select the item to be adjusted using ↑/↓.**

---

**4 Adjust the volume level using </>.**  
The adjusted value will appear on the front panel display. If you do not operate the remote for a few seconds, the value turns off and is stored in the receiver.

---

# Changing the Angles

If various angles (multi-angles) for a scene are recorded on the DVD, “ANGLE” appears in the front panel display. This means that you can change the viewing angle.

For example, while playing a scene of a train in motion, you can display the view from either the front of the train, the left window of the train, or from the right window without having the train’s movement interrupted.

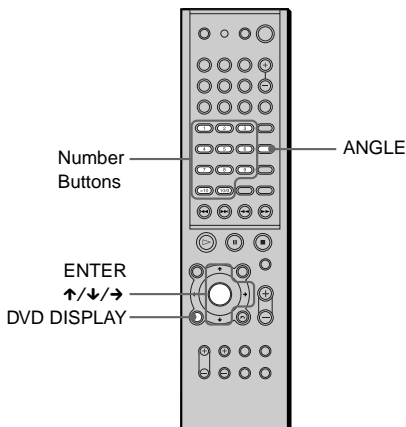

## 1 Press DVD DISPLAY during playback.

The Control Menu appears.

## 2 Press $\uparrow/\downarrow$ to select (ANGLE).

The angle number appears.  
The number in parentheses indicates the total number of angles.

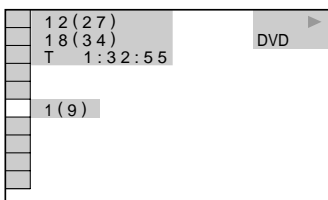

## 3 Press $\rightarrow$ or ENTER.

The angle number changes to “-.”

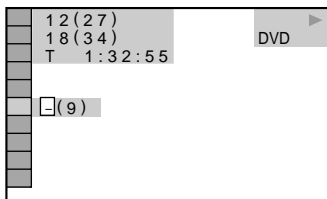

## 4 Select the angle number using the number buttons or $\uparrow/\downarrow$ , then press ENTER.

The angle is changed to the selected angle.

### To turn off the Control Menu

Press DVD DISPLAY repeatedly until the Control Menu is turned off.

 You can select the angle directly by pressing ANGLE. Each time you press the button, the angle changes.

### Note

Depending on the DVD, you may not be able to change the angles, even if multi-angles are recorded on the DVD.

# Displaying the Subtitles



If subtitles are recorded on the discs, you can turn the subtitles on and off while playing. If multilingual subtitles are recorded on the disc, you can change the subtitle language while playing, or turn the subtitles on or off whenever you want. For example, you can select the language you want to practice and turn the subtitles on for better understanding.

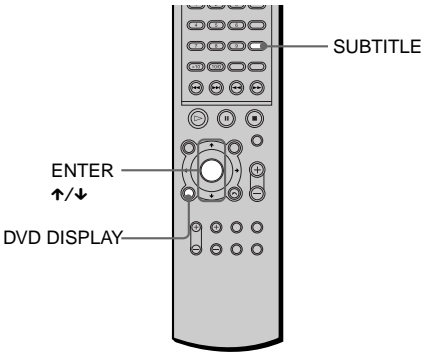

## 1 Press DVD DISPLAY during playback.

The Control Menu appears.

## 2 Press ↑/↓ to select (SUBTITLE), then press ENTER.

The options for SUBTITLE appear.

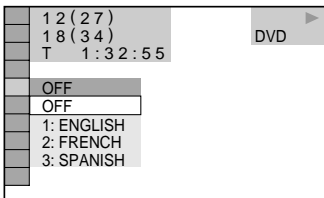

## 3 Press ↑/↓ to select the language.

Depending on the DVD, the choice of language varies.

When 4 digits are displayed, they indicate the language code. Refer to the language code list on page 79 to see which language the code represents.

## 4 Press ENTER.

### To cancel the SUBTITLE setting

Select "OFF" in Step 3.

### To turn off the Control Menu

Press DVD DISPLAY repeatedly until the Control Menu is turned off.

You can select SUBTITLE directly by pressing SUBTITLE. Each time you press the button, the item changes.

### Note

Depending on the DVD, you may not be able to change the subtitles even if multilingual subtitles are recorded on it.

# Checking the Play Information (ADVANCED)

You can check information such as the bit rate or the disc layer that is being played. While playing a disc, an approximate bit rate of the playback picture is always displayed as Mbps (Mega bit per second) and the audio as kbps (kilo bit per second).

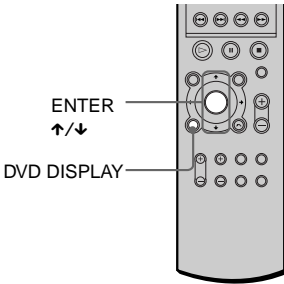

## 1 Press DVD DISPLAY during playback.

The Control Menu is displayed.

## 2 Press $\uparrow/\downarrow$ to select (ADVANCED), then press ENTER.

The options for ADVANCED appear.

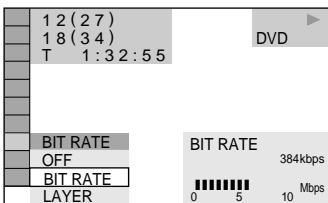

## 3 Press $\uparrow/\downarrow$ to select the items.

For each item, please refer to “Displays of each item.”

- BIT RATE: displays the bit rate.
- LAYER: displays the layer and the pick-up point.

## 4 Press ENTER.

### To close the ADVANCED window

Select “OFF” in Step 3.

### To turn off the Control Menu

Press DVD DISPLAY repeatedly until the Control Menu is turned off.

## Displays of each item

By pressing DVD DISPLAY repeatedly, you can display either “BIT RATE” or “LAYER,” whichever was selected in “ADVANCED.”

### BIT RATE

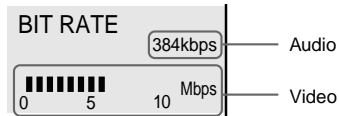

When playing MPEG audio sound tracks

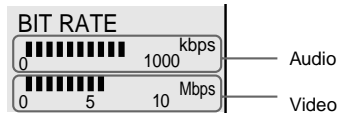

Bit rate refers to the amount of video/audio data per second in a disc. When the bit rate level is high, there is a large amount of data. However, this does not always mean that you can get higher quality pictures or sounds.

### LAYER

Appears when the DVD has dual layers



Indicates the approximate point where the disc is playing.

If it is a dual-layer DVD, the receiver indicates which layer is being read (“Layer 0” or “Layer 1”).

For details on the layers, see page 75 (DVD).

## Locking Discs (CUSTOM PARENTAL CONTROL, PARENTAL CONTROL)

You can set two kinds of playback restrictions for a disc.

- Custom Parental Control

You can set the playback restrictions so that the receiver will not play inappropriate discs.

- Parental Control

Playback of some DVDs can be limited according to a predetermined level such as the age of the users.

The same password is used for both Parental Control and Custom Parental Control.

### Custom Parental Control



You can set the same Custom Parental Control password for up to 50 discs. When you set the fifty-first-disc, the playback restriction for the first disc is cancelled.

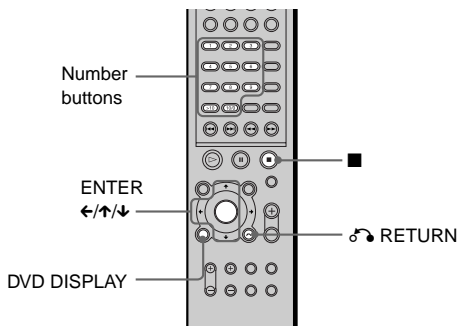

#### 1 Insert the disc you want to lock.

If the disc is playing, press **■** to stop playback.

#### 2 In stop mode, press DVD DISPLAY.

The Control Menu appears.

#### 3 Press $\uparrow/\downarrow$ to select **(CUSTOM PARENTAL CONTROL)**, then press ENTER.

“CUSTOM PARENTAL CONTROL” is selected.

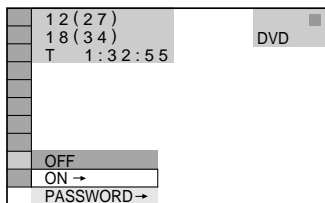

#### 4 Press $\uparrow/\downarrow$ to select “ON $\rightarrow$ ,” then press ENTER.

#### ■When you have not entered a password

The display for registering a new password appears.

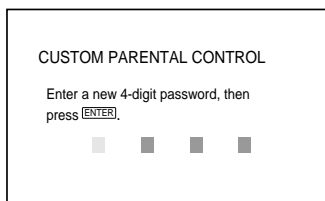

Enter a 4-digit password by using the number buttons, then press ENTER. The display for confirming the password appears.

#### ■When you have already registered a password

The display for entering the password appears.



**5 Enter or re-enter your 4-digit password by using the number buttons, then press ENTER.**

“Custom parental control is set.” appears and the screen returns to the Control Menu display.

**If you make a mistake entering your password**

Press ← before you press ENTER and input the correct number.

**If you make a mistake**

Press ⏪ RETURN, then start from Step 3 again.

**To turn off the Control Menu**

Press ⏪ RETURN, then press DVD DISPLAY repeatedly until the Control Menu is turned off.

**To turn off the Custom Parental Control function**

- 1 In Step 4, select “OFF →,” then press ENTER.
- 2 Enter your 4-digit password using the number buttons, then press ENTER.

**To change the password**

- 1 In Step 4, press ↑/↓ to select “PASSWORD →,” then press ENTER. The display for entering the password appears.
- 2 Enter your 4-digit password using the number buttons, then press ENTER.
- 3 Enter a new 4-digit password using the number buttons, then press ENTER.
- 4 To confirm your password, re-enter it using the number buttons, then press ENTER.

**Playing the disc for which Custom Parental Control is set**

**1 Insert the disc for which Custom Parental Control is set.**

The CUSTOM PARENTAL CONTROL display appears.

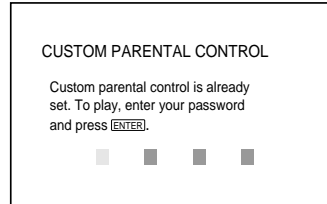

**2 Enter your 4-digit password using the number buttons, then press ENTER.**

The receiver is ready for playback.

**💡** If you forget your password, enter the 6-digit number “199703” using the number buttons when the CUSTOM PARENTAL CONTROL display asks you for your password, then press ENTER. The display will ask you to enter a new 4-digit password.

**Limiting playback for children (Parental Control) DVD**

Playback of some DVDs can be limited according to a predetermined level such as the age of the users. The “Parental Control” function allows you to set a playback limitation level.

A scene that is limited is not played, or it is replaced by a different scene.

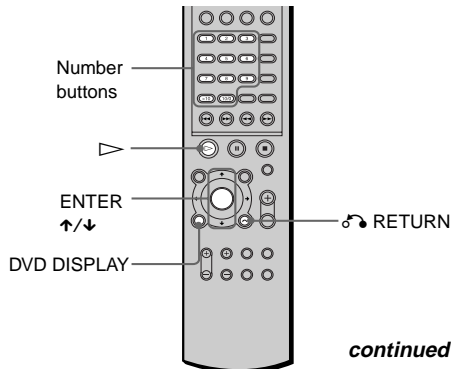

**1 In stop mode, press DVD DISPLAY.**

The Setup Display appears.

**2 Press  $\uparrow/\downarrow$  to select "CUSTOM SETUP," then press ENTER.**

"CUSTOM SETUP" is displayed.

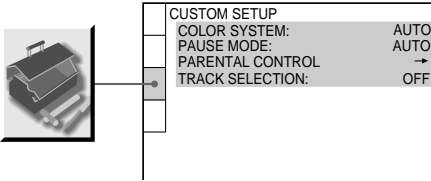

**4 Enter or re-enter your password using the number buttons, then press ENTER.**

The display for setting the playback limitation level and changing the password appears.

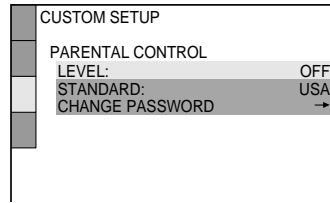

**3 Press  $\uparrow/\downarrow$  to select "PARENTAL CONTROL →," then press ENTER.**

**■ If you have not entered a password**

The display for registering a new password appears.

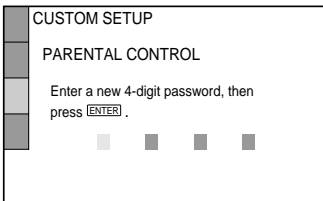

Enter a 4-digit password using the number buttons, then press ENTER. The display for confirming the password appears.

**■ When you have already registered a password**

The display for entering the password appears.

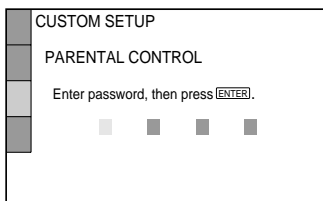

**5 Press  $\uparrow/\downarrow$  to select "STANDARD," then press ENTER.**

The selection items for "STANDARD" are displayed.

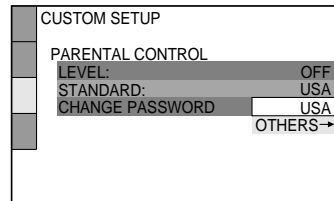

**6 Press  $\uparrow/\downarrow$  to select a geographic area as the playback limitation level, then press ENTER.**

The area is selected.

If you select "OTHERS →," select and enter the standard code in the table on page 58 using the number buttons.



## 7 Press ENTER.

The selection items for “LEVEL” are displayed.

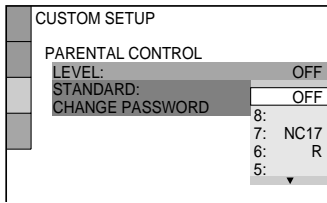

## 8 Select the level you want using $\uparrow/\downarrow$ , then press ENTER.

Parental Control setting is complete.

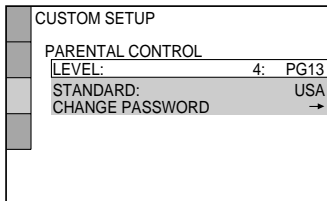

The lower the value, the more strict the limitation.

### If you make a mistake

Press  $\delta$  RETURN to go back to the previous screen.

### To turn off the Setup Display

Press DVD SETUP repeatedly until the Setup Display is turned off.

### To turn off the Parental Control function and play the DVD after entering your password

Set “LEVEL” to “OFF” in Step 8.

### To change the password

**1** In Step 5, select “CHANGE PASSWORD  $\rightarrow$ ” using  $\downarrow$ , then press ENTER.

The display for entering the password appears.

**2** Follow Step 3 to enter a new password.

## Playing the disc for which Parental Control is set

### 1 Insert the disc and press $\triangleright$ .

The PARENTAL CONTROL display appears.

### 2 Enter your 4-digit password using the number buttons, then press ENTER.

The receiver starts playback.

If you forget your password, remove the disc and repeat Step 1 to 5 of “Limiting playback for children.” When you are asked to enter your password, enter “199703” using the number buttons, then press ENTER. The display will ask you to enter a new 4-digit password. After you enter a new 4-digit password in Step 3, replace the disc in the receiver and press  $\triangleright$ . When the PARENTAL CONTROL display appears, enter your new password.

### Notes

- When you play DVDs which do not have the Parental Control function, playback cannot be limited on this receiver.
- Depending on the DVD, you may be asked to change the parental control level while playing the disc. In this case, enter your password, then change the level. If the Resume Play mode is cancelled, the level returns to the original level.

## Area Code

<b>Standard</b>	<b>Code number</b>	<b>Standard</b>	<b>Code number</b>
Argentina	2044	Korea	2304
Australia	2047	Malaysia	2363
Austria	2046	Mexico	2362
Belgium	2057	Netherlands	2376
Brazil	2070	New Zealand	2390
Canada	2079	Norway	2379
Chile	2090	Pakistan	2427
China	2092	Philippines	2424
Denmark	2115	Portugal	2436
Finland	2165	Russia	2489
France	2174	Singapore	2501
Germany	2109	Spain	2149
Hong Kong	2219	Sweden	2499
India	2248	Switzerland	2086
Indonesia	2238	Taiwan	2543
Italy	2254	Thailand	2528
Japan	2276	United Kingdom	2184

## Controlling the TV with the Supplied Remote

By adjusting the remote signal, you can control your TV with the supplied remote.

### Notes

- If you enter a new code number, the code number previously entered will be erased.
- When you replace the batteries of the remote, the code number may be reset to the default (SONY) setting. Reset the appropriate code number.

### Controlling TVs with the remote

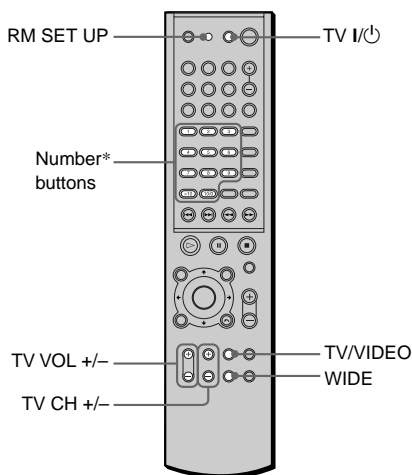

#### 1 Press TV I/II while pressing RM SET UP.

The SET UP indicator lights up.

#### 2 Enter your TV's manufacturer's code (see the table) using the number buttons.

The SET UP indicator flashes twice.

### Code numbers of controllable TVs

If more than one code number is listed, try entering them one at a time until you find the one that works with your TV.

Manufacturer	Code number
AIWA	17
AKAI	22
AOC	22
CENTURION	28
COLONAD	21
CURTIS-MATHES	28
Daytron	28
EMERSON	21, 22, 30
FISHER	27
FUJITSU	11
FUNAI	14
General Electric	24, 26
GOLD STAR (LG)	21, 22, 32
GRUNDIG	44
HITACHI	04, 21, 51
J.C.Penney	22, 28
JVC	06
KMC	21
LOEWE	56
MAGNAVOX	21, 25, 28
MARANTZ	22, 29
MGA/MITUBISHI	22, 28, 29, 32
NEC	09, 22, 28
NOKIA	47, 48, 58
PANASONIC (MATSUSHITA)	02, 13, 24, 57
Philico	21, 22
PHILIPS	25, 34, 41, 42, 43
PIONEER	10
Portland	21
QUASAR	08, 24
RADIO SHACK	23, 30
RCA	22, 26
SABA	45, 46
SAMPO	28
SAMSUNG	18, 33, 49, 50
SANYO	07, 15, 27, 52
SCOTT	28
SEARS	03, 26, 27
SHARP	08, 16, 21, 23
SONY	01 (default), 12
SYLVANIA	25, 28
TEKNIKA	21, 25, 30
TELEFUNKEN	53
THOMSON	55
TOSHIBA	03, 54
WARDS	21, 22, 28
YORX	28
ZENITH	31

## Controlling the TV

You can control your TV using the buttons below.

By pressing	You can
TV I/⏻	Turn the TV on or off.
TV/VIDEO	Switch the TV's input source between the TV and other input sources.
TV VOL +/-	adjust the TV volume.
TV CH +/-	change the TV channel.
WIDE	change the aspect ratio of your TV.

### Note

Depending on the TV, you may not be able to control your TV or to use some of the buttons above.

- \* Use the number buttons only to enter the code number of controllable TVs.

## Watching the Video or other Unit

You can use VCR or other units connected to the VIDEO (S VIDEO/AUDIO L/R IN/OUT) jacks. Refer to the operation manual supplied with the unit for further information on the operation.

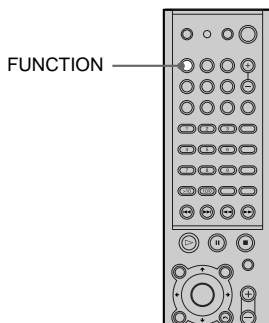

### Press FUNCTION repeatedly until "VIDEO" appears on the front panel display.

Each time you press FUNCTION, the mode of the receiver changes in the following sequence.

DVD → VIDEO → TV/SAT → AUX → MD/DAT → TUNER → DVD...

### Note

You can listen to other equipment (cassette deck, satellite tuner, etc.) connected to the receiver by pressing FUNCTION and selecting the connected input.

# Listening to the Radio

Preset radio stations in the receiver's memory first (see "Presetting Radio Stations" on page 28).

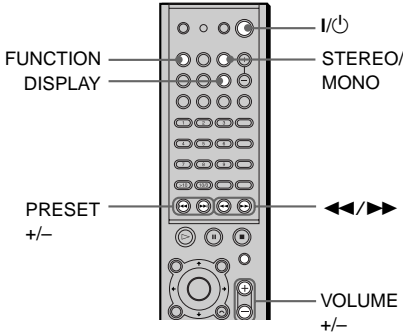

## To listen to non-preset radio stations

Use manual or automatic tuning in Step 2. For manual tuning, press **<<** or **>>** on the remote repeatedly.

For automatic tuning, press and hold **<<** or **>>** on the remote.

### 💡 If an FM programme is noisy

Press **STEREO/MONO** on the remote so that "MONO" appears on the front panel display. There will be no stereo effect, but the reception will improve. Press the button again to restore the stereo effect.

### 💡 To improve reception

Reorient the supplied antennas.

## To check the frequency or sound field

Press **DISPLAY** repeatedly.

Each time you press **DISPLAY**, the front panel display changes as follows:  
 index name of the station → frequency →  
 sound field → index name of the station

- 1 Press FUNCTION repeatedly until "TUNER" appears on the front panel display.**

The last received station is tuned in.

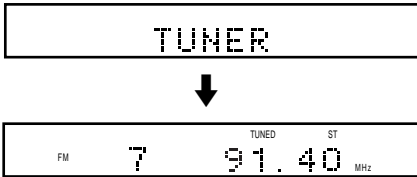

- 2 Press PRESET + or PRESET - repeatedly to select the preset station you want.**

Each time you press the button, the receiver tunes in one preset station.

- 3 Adjust the volume by pressing VOLUME +/-.**

## To turn off the radio

Press **I/⏻**.

---

# Naming Preset Stations

You can enter a name of up to 8 characters for preset stations. These names (for example, "XYZ") appear on the front panel display when a station is selected.

Note that no more than one name can be entered for each preset station.

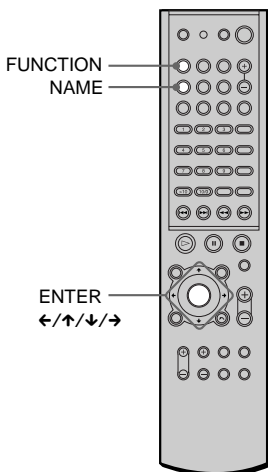

---

## 1 Press FUNCTION repeatedly until "TUNER" appears on the front panel display.

The last station you received is tuned in.

Each time you press FUNCTION, the mode of the receiver changes in the following sequence:

DVD → VIDEO → TV/SAT → AUX  
→ MD/DAT → TUNER → DVD...

---

## 2 Tune in the preset station you want to create an index name for.

If you are not familiar with how to tune in preset stations, see "Listening to the Radio" on page 61.

---

## 3 Press NAME.

---

## 4 Create an index name by using the cursor buttons:

Press ↓/↑ to select a character, then press → to move the cursor to the next position.

### If you make a mistake

Press ← or → repeatedly until the character to be changed flashes, then press ↓/↑ to select the right character.

---

## 5 Press ENTER.

### To assign index names to other stations

Repeat Steps 2 to 5.

# Using the Setup Display



By using the Setup Display, you can make various adjustments to items such as picture and sound. You can also set a language for the subtitles and the Setup Display, among other things. For details on each Setup Display item, see page 64-70. For an overall list of Setup Display items, see page 80.

## How to use the Setup Display

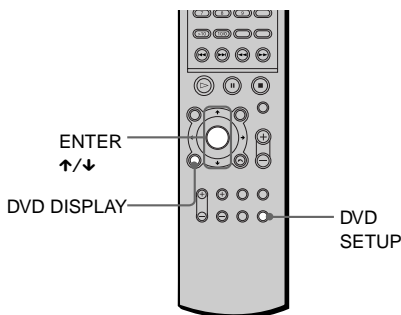

### 1 In stop mode, press DVD DISPLAY.

The Control Menu appears.  
If you press DVD SETUP, you can go to Step 3 directly.

### 2 Press ↑/↓ to select (SETUP), then press ENTER.

The options for SETUP appear.

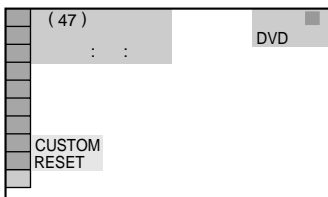

### 3 Press ↑/↓ to select "CUSTOM," then press ENTER.

The Setup Display appears.

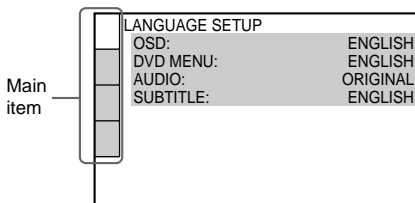

### 4 Press ↑/↓ to select the setup item from the displayed list: "LANGUAGE SETUP," "SCREEN SETUP," "CUSTOM SETUP," and "SPEAKER SETUP." Then press ENTER.

The selected Setup item appears.

Example: "SCREEN SETUP"

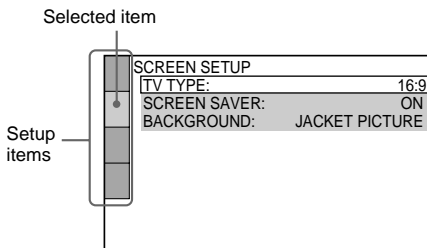

## 5 Select an item using $\uparrow/\downarrow$ , then press ENTER.

The options for the selected item appear.  
Example: "TV TYPE"

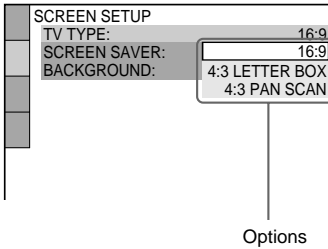

## 6 Select a setting using $\uparrow/\downarrow$ , then press ENTER.

The setting is selected and setup is complete.  
Example: "4:3 PAN SCAN"

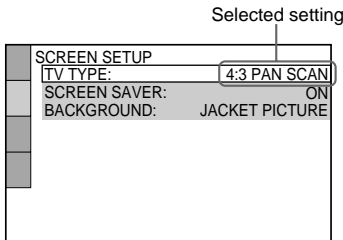

### To turn off the Setup Display

Press DVD SETUP or DVD DISPLAY repeatedly until the Setup Display is turned off.

 If you select "RESET" in Step 2, you can reset all of the "SETUP" settings on page 80 (except for PARENTAL CONTROL) to the default settings. After you select "RESET" and press ENTER, select "YES" to reset the settings (it takes a few seconds to complete), or select "NO" and press ENTER to return to the Control Menu. Do not press POWER or  $\text{I}/\text{O}$  when resetting the receiver.

## Setting the Display or Sound Track Language (LANGUAGE SETUP)



"LANGUAGE SETUP" allows you to set various languages for the on-screen display or sound track.

Select "LANGUAGE SETUP" in the Setup Display. For details on using the display, see "Using the Setup Display" (page 63).

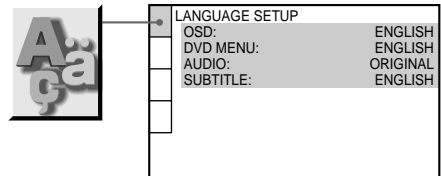

### ■ OSD (On-Screen Display)

Switches the display language on the screen. Selects the language from the displayed list.

### ■ DVD MENU (DVD only)

Selects the desired language for the DVD menu.

### ■ AUDIO (DVD only)

Switches the language of the sound track. Selects the language from the displayed list. When you select "ORIGINAL," the language given priority in the disc is selected.

### ■ SUBTITLE (DVD only)

Switches the language of the subtitle. Selects the language from the displayed list. When you select "AUDIO FOLLOW," the language for the subtitles changes according to the language you selected for the sound track.



 If you select “OTHERS →” in “DVD MENU,” “SUBTITLE,” or “AUDIO,” select and enter the language code from the list using the number buttons (page 79).

After you have made a selection, the language code (4 digits) is displayed the next time you select “OTHERS →.”

**Note**

If you select a language that is not recorded on the DVD, one of the recorded languages will be automatically selected (except for the “OSD”).

# Settings for the Display

**(SCREEN SETUP)** **DVD** **VIDEO CD** **SA-CD CD**

Choose settings according to the TV to be connected.

Select “SCREEN SETUP” in the Setup Display. For details on using the display, see “Using the Setup Display” (page 63).

The default settings are underlined.

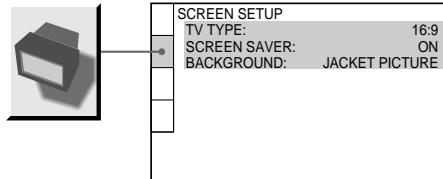

**■ TV TYPE (DVD only)**

Selects the aspect ratio of the connected TV (4:3 standard or wide).

The default settings vary, depending on the country model.

16:9	Select this when you connect a wide-screen TV or a TV with a wide mode function.
4:3 LETTER BOX	Select this when you connect a 4:3 screen TV. Displays a wide picture with bands on the upper and lower portions of the screen.
4:3 PAN SCAN	Select this when you connect a 4:3 screen TV. Automatically displays the wide picture on the entire screen and cuts off the portions that do not fit.

16:9

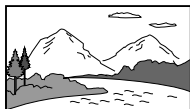

4:3 LETTER BOX



4:3 PAN SCAN



### Note

Depending on the DVD, “4:3 LETTER BOX” may be selected automatically instead of “4:3 PAN SCAN” or vice versa.

### SCREEN SAVER

Turns the screen saver on and off so that the screen saver image appears when you leave the receiver in pause or stop mode for 15 minutes, or when you play back a CD for more than 15 minutes. The screen saver will help prevent your display device from becoming damaged (ghosting). Press  to turn off the screen saver.

<u>ON</u>	Turns on the screen saver.
OFF	Turns off the screen saver.

### BACKGROUND

Selects the background colour or picture on the TV screen in stop mode or while playing a CD.

<u>JACKET PICTURE</u>	The jacket picture (still picture) appears in the background, but only when the jacket picture is already recorded on the disc (CD-EXTRA, etc.). If the disc does not contain a jacket picture, the “GRAPHICS” picture appears.
GRAPHICS	A preset picture stored in the receiver appears in the background.
BLUE	The background colour is blue.
BLACK	The background colour is black.

## Custom Settings (CUSTOM

SETUP)   

Allows setting up Parental Control and other settings.

Select “CUSTOM SETUP” in the Setup Display. For details on using the display, see “Using the Setup Display” (page 63). The default settings are underlined.

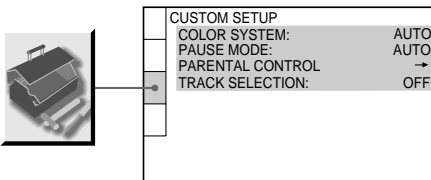

### COLOR SYSTEM for VIDEO CD playback (Asian models only)

Select the colour system when you play a VIDEO CD.

<u>AUTO</u>	Outputs the video signal in the system of the disc, either PAL or NTSC. If your TV uses a DUAL system, select AUTO.
PAL	Changes the video signal of an NTSC disc and output in the PAL system.
NTSC	Changes the video signal of a PAL disc and output in the NTSC system.

### Notes

- You cannot change the colour system of the disc itself.
- On Asian models, you can change the colour system of the system according to the connected TV. See page 22.

## ■ PAUSE MODE (DVD only)

Selects the picture in pause mode.

AUTO	The picture, including subjects that move dynamically, is output with no jitter. Normally select this position.
FRAME	The picture, including subjects that do not move dynamically, is output in high resolution.

## ■ PARENTAL CONTROL → (DVD only)

Sets a password and playback limitation level for DVDs with playback limitation for children. For details, see “Limiting playback for children (Parental Control)” (page 55).

## ■ TRACK SELECTION (DVD only)

Gives the sound track having the highest number of channels priority when you play a DVD on which multiple audio formats (PCM, MPEG audio, DTS, or Dolby Digital format) are recorded.

OFF	No priority given.
AUTO	Priority given.

### Notes

- When you set the item to “AUTO,” the language may change. The “TRACK SELECTION” setting has higher priority than the “AUDIO” settings in “LANGUAGE SETUP” (page 64).
- If PCM, DTS, MPEG audio, and Dolby Digital sound tracks have the same number of channels, the receiver selects PCM, DTS, Dolby Digital, and MPEG audio sound tracks in this order.
- Depending on the DVD, the audio channel with priority may be predetermined. In this case, you cannot give priority to the DTS, Dolby Digital, or MPEG audio format by selecting “AUTO.”

## Settings for the Speakers (SPEAKER SETUP)

To obtain the best possible surround sound, set the size of the speakers you have connected and their distance from your listening position. Then use the test tone to adjust the volume and the balance of the speakers to the same level.

Select “SPEAKER SETUP” in the setup display. For details, see “Using the Setup Display” (page 63).

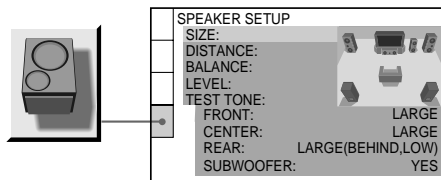

### To return to the default setting

Select the item, then press CLEAR.

### ■ SIZE

When you do not connect centre or rear speakers, or move the rear speakers, set the parameters for FRONT, CENTER, REAR, and SUBWOOFER. The default settings are underlined.

- FRONT
  - LARGE: Normally select this.
  - SMALL: Select this if the small speakers are used for the front speaker.
- CENTER
  - LARGE: Normally select this.
  - SMALL: Select this if the small speaker is used for the centre speaker.
  - NONE: Select this if no centre speaker is used.

• REAR

- LARGE (BEHIND, LOW), LARGE (BEHIND, HIGH), LARGE (SIDE, LOW), LARGE (SIDE, HIGH), SMALL (BEHIND, LOW), SMALL (BEHIND, HIGH), SMALL (SIDE, LOW), SMALL (SIDE, HIGH):

Specify the position and height to implement the Digital Cinema Surround modes in the “Virtual Multi Dimension” sound field (page 48) properly.

- NONE: Select this if no rear speaker is used.

• SUBWOOFER

- YES: Select this if the subwoofer is used.
- NONE: Select this if no subwoofer is used.

**Notes**

- When you select an item, the sound cuts off for a moment.
- Depending on the settings of other speakers, the subwoofer may output excessive sound.

**Specifying the rear speaker position and height**

If you select anything other than “NONE” in “REAR,” specify the position and height of the rear speakers. The default setting is underlined.

LARGE ( <u>BEHIND, LOW</u> ), SMALL (BEHIND, LOW)	Select this if the rear speakers are located in section <b>B</b> and <b>D</b> .
LARGE (BEHIND, HIGH), SMALL (BEHIND, HIGH)	Select this if the rear speakers are located in section <b>B</b> and <b>C</b> .
LARGE (SIDE, LOW), SMALL (SIDE, LOW)	Select this if the rear speakers are located in section <b>A</b> and <b>D</b> .
LARGE (SIDE, HIGH), SMALL (SIDE, HIGH)	Select this if the rear speakers are located in section <b>A</b> and <b>C</b> .

These parameters are not available when “REAR” is set to “NONE.”

Position diagram

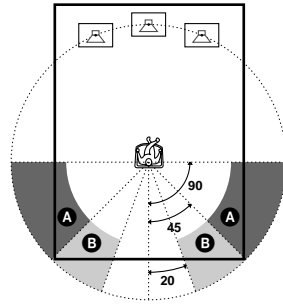

Height diagram

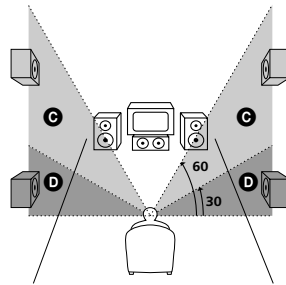

■ DISTANCE

The default distance setting for the speakers in relation to the listening position is shown below.

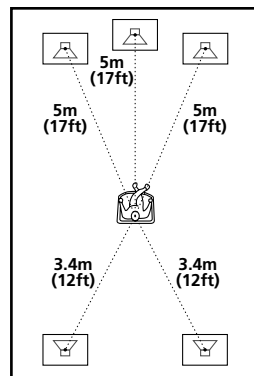

Be sure to change the value in the Setup Display when you move the speakers. The default settings are underlined.

<b>FRONT</b> <u>5 m/17 ft</u>	Front speaker distance from the listening position can be set in 0.2 meter (1 foot) increments from 1 to 15 meters (3 to 50 feet).
<b>CENTER</b> <u>5 m/17 ft</u>	Centre speaker distance can be moved up to 1.6 meters (5 feet) forward closer to the listening position, in 0.2 meter (1 foot) increments.
<b>REAR</b> <u>3.4 m/</u> <u>12 ft</u>	Rear speaker distance can be moved up to 4.6 meters (15 feet) closer to your listening position from the front speaker position, in 0.2 meter (1 foot) increments.

### Notes

- When you set the distance, the sound cuts off for a moment.
- If each of the front or rear speakers are not placed at an equal distance from your listening position, set the distance according to the closest speaker.
- Do not place the rear speakers farther away from your listening position than the front speakers.

### BALANCE

You can vary the balance of the left and right speakers as follows. Be sure to set “TEST TONE” to “ON” for easy adjustment. The default settings are underlined.

<b>FRONT</b> <u>CENTRE</u>	Adjust the balance between the front left and right speakers (You can adjust from centre 6 steps left or right).
<b>REAR</b> <u>CENTRE</u>	Adjust the balance between the rear left and right speakers (You can adjust from centre 6 steps left or right).

### LEVEL

You can vary the level of each speaker as follows. Be sure to set “TEST TONE” to “ON” for easy adjustment. The default settings are underlined.

<b>CENTER</b> <u>0 dB</u>	Adjusts the level of the centre speaker (–10 dB to +10 dB, 1dB increments).
<b>REAR</b> <u>0 dB</u>	Adjusts the level of the rear speakers (–10 dB to +10 dB, 1dB increments).
<b>SUBWOOFER</b> <u>0 dB</u>	Adjusts the level of the subwoofer (–10 dB to +10 dB, 1dB increments).

### To adjust the volume of all the speakers at one time

Use the VOLUME control.

### TEST TONE

The speakers will emit a test tone to adjust “BALANCE” and “LEVEL.” The default setting is underlined.

<u>OFF</u>	The test tone is not emitted from the speakers.
<u>ON</u>	The test tone is emitted from each speaker in sequence while adjusting balance or level. When you select one of the “SPEAKER SETUP” items, the test tone is emitted from both left and right speakers simultaneously.

## Adjusting the speaker volume and level

---

- 1** After you stop playback, select “SPEAKER SETUP” after pressing DVD SETUP in the Setup Display.

---
- 2** Select “TEST TONE” and set “TEST TONE” to “ON.”  
You will hear the test tone from each speaker in sequence.

---
- 3** From your listening position, select “BALANCE” or “LEVEL” and adjust the value of “BALANCE” and “LEVEL” using ↑/↓.  
The test tone is emitted from both left and right speakers simultaneously.

---
- 4** Select “TEST TONE” and set “TEST TONE” to “OFF” to turn off the test tone.

---

### Note

When you adjust the speaker settings, the sound cuts off for a moment.

## Troubleshooting

If you experience any of the following difficulties while using the receiver, use this troubleshooting guide to help remedy the problem before requesting repairs. Should any problem persist, consult your nearest Sony dealer.

### Power

#### The power is not turned on.

- ➔ Check that the AC power cord (mains lead) is connected securely.

### Picture

#### There is no picture.

- ➔ The connecting cords are not connected securely.
- ➔ The connecting cords are damaged.
- ➔ The receiver is not connected to the correct TV input jack (page 21).
- ➔ The video input on the TV is not set so that you can view pictures from the receiver.

#### Picture noise appears.

- ➔ The disc is dirty or flawed.
- ➔ If the picture output from your receiver goes through your VCR to get to your TV, the copy-protection signal applied to some DVD programmes could affect picture quality.

#### Even though you set the aspect ratio in "TV TYPE" of "SCREEN SETUP," the picture does not fill the screen.

- ➔ The aspect ratio of the disc is fixed on your DVD.

#### The picture is black and white.

- ➔ Depending on the TV, the picture on the screen becomes black and white when you play a disc recorded in the NTSC colour system.

### Sound

#### There is no sound.

- ➔ The connecting cord is not connected securely.
- ➔ The connecting cord is damaged.
- ➔ Press MUTING on the remote if "MUTING ON" is displayed on the front panel display.
- ➔ The protective device on the receiver has been activated because of a short circuit. Turn off the receiver, eliminate the short-circuit problem and turn on the power again.
- ➔ The audio connecting cord is damaged. Replace it with a new one.
- ➔ The receiver is in pause mode or in Slow-motion Play mode. Press ▷ to return to normal play mode.
- ➔ Fast forward or fast reverse is performed. Press ▷ to return to normal play mode.
- ➔ Check the speaker settings (pages 23, 67).

#### The left and right sounds are unbalanced or reversed.

- ➔ Check that the speakers and components are connected correctly and securely.
- ➔ Adjust the front balance parameter in the LEVEL menu (pages 26, 69).

#### Severe hum or noise is heard.

- ➔ Check that the speakers and components are connected securely.
- ➔ Check that the connecting cords are away from a transformer or motor, and at least 3 meters (10 feet) away from a TV set or fluorescent light.
- ➔ Move your TV away from the audio components.
- ➔ The plugs and jacks are dirty. Wipe them with a cloth slightly moistened with alcohol.
- ➔ Clean the disc.

#### The sound loses stereo effect when you play a VIDEO CD, or a CD.

- ➔ Set "AUDIO" to "STEREO" in the Control Menu display (page 44).
- ➔ Make sure you connect the receiver appropriately.

---

**The surround effect is difficult to hear when you are playing a Dolby Digital sound track.**

- ➔ Make sure the sound field function is on (page 46).
- ➔ Check the speaker connections and settings (pages 16, 23, 67).
- ➔ Depending on the DVD, the output signal may not be the entire 5.1 channels. It may be monaural or stereo even if the sound track is recorded in Dolby Digital format.

---

**The surround effect is difficult to hear when you are playing a Dolby Digital or MPEG audio sound track.**

- ➔ Check the speaker connections and setting (pages 16, 23, 67).
- ➔ Depending on the DVD, the output signal may not be the entire 5.1 channels. It may be monaural or stereo even if the sound track is recorded in Dolby Digital or MPEG audio format.

---

**The sound comes from the centre speaker only.**

- ➔ Depending on the disc, the sound may come from the centre speaker only.

---

**No sound is heard from the centre speaker.**

- ➔ Make sure the sound field function is on (page 46).
- ➔ Select a sound field containing the word “cinema” or “virtual” (page 46).

---

**No sound or only a very low-level sound is heard from the rear speakers.**

- ➔ Make sure the sound field function is on (page 46).
- ➔ Select a sound field containing the word “cinema” or “virtual” (page 46).

## Operation

---

**Radio stations cannot be tuned in.**

- ➔ Check that the antennas are connected securely. Adjust the antennas and connect an external antenna if necessary.
- ➔ The signal strength of the stations is too weak (when tuning in with automatic tuning). Use direct tuning.
- ➔ No stations have been preset or the preset stations have been cleared (when tuning by scanning preset stations). Preset the stations (page 28).
- ➔ Press DISPLAY so that the frequency appears on the front panel display.

---

**The remote does not function.**

- ➔ There are obstacles between the remote and the receiver.
- ➔ The distance between the remote and the receiver is too far.
- ➔ The remote is not pointed at the remote sensor on the receiver.
- ➔ The batteries in the remote are weak.

---

**The disc does not play.**

- ➔ There is no disc inside.
- ➔ The disc is turned over.  
Insert the disc with the playback side facing down on the disc tray.
- ➔ The disc is skewed.
- ➔ The receiver cannot play CD-ROMs, etc. (page 7).
- ➔ The region code on the DVD does not match the receiver.
- ➔ Moisture has condensed inside the receiver.  
Remove the disc and leave the receiver turned on for about half an hour (page 3).



---

### **The disc does not start playing from the beginning.**

- ➔ Programme Play, Shuffle Play, or Repeat Play has been selected (pages 34-37). Press CLEAR to cancel these functions before playing a disc.
- ➔ Resume Play has been selected. During stop, press ■ on the receiver or the remote and then start DVD playback (page 31).
- ➔ The title, DVD or PBC menu automatically appears on the TV screen.

---

### **The receiver starts playing the disc automatically.**

- ➔ The DVD features an auto playback function.

---

### **Playback stops automatically.**

- ➔ Some discs may contain an auto pause signal. While playing such a disc, the receiver stops playback at the auto pause signal.

---

### **You cannot perform some functions such as Stop, Search, Slow-motion Play, Repeat Play, Shuffle Play, or Programme Play.**

- ➔ Depending on the disc, you may not be able to do some of the operations above. See the operating manual that comes with the disc.

---

### **Messages do not appear on the screen in the language you want.**

- ➔ In the Setup Display, select the desired language for the on-screen display in “OSD” under “LANGUAGE SETUP” (page 64).

---

### **The language for the sound track cannot be changed.**

- ➔ Multilingual tracks are not recorded on the DVD being played.
- ➔ The DVD prohibits changing the language for the sound track.

---

### **The subtitle language cannot be changed.**

- ➔ Multilingual subtitles are not recorded on the DVD being played.
- ➔ The DVD prohibits changing the subtitles.

---

### **The subtitle cannot be turned off.**

- ➔ The DVD prohibits turning off subtitles.

---

### **The angles cannot be changed.**

- ➔ Multi-angles are not recorded on the DVD being played. The angle can be changed only when the “ANGLE” indicator lights up on the front panel display.
- ➔ The DVD prohibits changing the angles.

---

### **The receiver does not operate properly.**

- ➔ If static electricity, etc., causes the receiver to operate abnormally, press POWER on the receiver to turn the receiver off and then on again.

---

### **Nothing is displayed on the front panel display.**

- ➔ Press DIMMER on the remote.

---

### **A 5-character service number is displayed on the screen and on the front panel display.**

- ➔ The self-diagnosis function was activated. (See the table on page 74.)

---

### **The disc tray does not open and “LOCKED” appears on the front panel display.**

- ➔ Contact your Sony dealer or local authorized Sony service facility.

---

### **“PROTECT” appears on the front panel display.**

- ➔ The speaker protection circuit is in function. Check the speaker connections.

---

# Self-diagnosis Function

(When letters/numbers appear on the front panel display)

The self-diagnosis function is activated to prevent the receiver from malfunctioning. In this case a five-character service number (e.g., C 13 00) with a combination of a letter and digits appears on the screen and the front panel display. Refer to the following table.

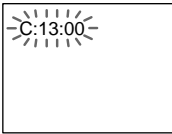

---

First three characters of the service number	Cause and/or Corrective Action
C 13	The disc is dirty. ➔ Clean the disc with a soft cloth (page 8).
C 31	The disc is not inserted correctly. ➔ Re-insert the disc correctly.
E XX (xx is a number)	To prevent a malfunction, the receiver has performed the self-diagnosis function. ➔ Contact your nearest Sony dealer or local authorized Sony service facility and give the 5-character service number. Example: E 61 10

---

---

# Glossary

## Bit rate

Value indicating the amount of video data compressed in a DVD per second. The unit is Mbps (Mega bit per second). 1 Mbps indicates that the data per second is 1,000,000 bits. The higher the bit rate is, the larger the amount of data. However, this does not always mean that you can get higher quality pictures.

---

## Chapter

Sections of a picture or a music piece on a DVD that are smaller than titles. A title is composed of several chapters. Each chapter is assigned a chapter number enabling you to locate the chapter you want.

---

## Digital Cinema Sound (DCS)

This is the generic name of the surround sound produced by digital signal processing technology developed by Sony. Unlike previous surround sound fields mainly directed at the reproduction of music, Digital Cinema Sound is designed specifically for the enjoyment of movies.

---

## Dolby Digital

This sound format for movie theaters is more advanced than Dolby Pro Logic Surround. In this format, the rear speakers output stereo sound with an expanded frequency range and a subwoofer channel for deep bass is independently provided. This format is also called "5.1" because the subwoofer channel is counted as 0.1 channel (since it functions only when a deep bass effect is needed). All six channels in this format are recorded separately to realize superior channel separation. Furthermore, since all the signals are processed digitally, less signal degradation occurs.

---

## Dolby Pro Logic Surround

As one method of decoding Dolby Surround, Dolby Pro Logic Surround produces four channels from two-channel sound. Compared with the former Dolby Surround system, Dolby Pro Logic Surround reproduces left-to-right panning more naturally and localizes sounds more precisely. To take full advantage of Dolby Pro Logic Surround, you should have one pair of rear speakers and a centre speaker. The rear speakers output monaural sound.

---

## DTS

Digital audio compression technology that the Digital Theater Systems, Inc. developed. This technology conforms to 5.1-channel surround. The rear channel is stereo and there is discrete subwoofer channel in this format. DTS provides the same 5.1 discrete channels of high quality digital audio. The good channel separation is realized because all the channel data is recorded discrete and processed in digital.

---

## DVD

A disc that contains up to 8 hours of moving pictures even though its diameter is the same as a CD.

The data capacity of a single-layer and single-sided DVD, at 4.7 GB (Giga Byte), is 7 times that of a CD. Furthermore, the data capacity of a dual-layer and single-sided DVD is 8.5 GB, a single-layer and double-sided DVD 9.4 GB, and a dual-layer and double-sided DVD 17 GB.

The picture data uses the MPEG 2 format, one of the worldwide standards of digital compression technology. The picture data is compressed to about 1/40 of its original size. The DVD also uses the variable rate coding technology that changes the data to be allocated according to the status of the picture.

The audio data is recorded in Dolby Digital as well as in PCM, allowing you to enjoy more real audio presence.

Furthermore, various advanced functions such as the multi-angle, multilingual, and Parental Control functions are provided with the DVD.

---

## Index (Super Audio CD/CD)/Video Index (VIDEO CD)

A number that divides a track into sections to easily locate the point you want on an Super Audio CD/CD or VIDEO CD.

Depending on the disc, no index may be recorded.

---

## Multi-angle function

Various angles, or viewpoints of the video camera for a scene are recorded on some DVDs.

---

## Multilingual function

Several languages for the sound or subtitles in a picture are recorded on some DVDs.

---

## Parental Control

A function of the DVD to limit playback of the disc by the age of the users according to the limitation level in each country. The limitation varies from disc to disc; when it is activated, playback is completely prohibited, violent scenes are skipped or replaced with other scenes and so on.

---

## Playback Control (PBC)

Signals encoded on VIDEO CDs (Version 2.0) to control playback.

By using menu screens recorded on VIDEO CDs with PBC functions, you can enjoy playing simple interactive programmes, programmes with search functions, and so on.

---

## Region Code

This receiver is used to protect copyrights. A region number is allocated on each DVD system or DVD disc according to the sales region. Each region code is shown on the receiver as well as on the disc packaging. The receiver can play the discs that match its region code. The receiver can also play discs with the “” mark. Even when the region code is not shown on the DVD, the region limit may still be activated.

---

## Scene

On a VIDEO CD with PBC (playback control) functions, the menu screens, moving pictures and still pictures are divided into sections called “scenes.”

---

## Super Audio CD

This audio format is based upon the current audio CD standards but includes a greater amount of information which provides higher quality sound. There are three types of discs: single layer, double layer and hybrid discs. The hybrid disc contains both standard audio CD and Super Audio CD information.

---

## Title

The longest sections of a picture or music feature on a DVD, movie, etc., in video software, or the entire album in audio software. Each title is assigned a title number enabling you to locate the title you want.

---

## Track

Sections of a picture or a music piece on a CD or VIDEO CD. Each track is assigned a track number enabling you to locate the track you want.

---

## VIDEO CD

A compact disc that contains moving pictures.

The picture data uses the MPEG 1 format, one of the worldwide standards of digital compression technology. The picture data is compressed to about 1/140 of its original size. Consequently, a 12 cm VIDEO CD can contain up to 74 minutes of moving pictures. VIDEO CDs also contain compact audio data. Sounds outside the range of human hearing are compressed while the sounds we can hear are not compressed. VIDEO CDs can hold 6 times the audio information of conventional audio CDs.

There are 2 versions of VIDEO CDs.

- Version 1.1: You can play only moving pictures and sounds.
- Version 2.0: You can play high-resolution still pictures and enjoy PBC functions.

This receiver conforms to both versions.

---

# Specifications

## Amplifier section

Stereo mode 50 W + 50 W (6 ohms at 1 kHz, THD 10 %)  
Surround mode Front: 50 W + 50 W  
Center\*: 50 W  
Rear\*: 50 W + 50 W (6 ohms at 1 kHz, THD 10 %)

\* Depending on the sound field settings and the source, there may be no sound output.

Inputs (Analog) VIDEO IN, AUX IN:  
Sensitivity: 150 mV  
Impedance: 50 kilohms

Inputs (Digital) MD/DAT IN, TV/SAT IN OPTICAL:  
Sensitivity: –

Outputs (Analog) VIDEO OUT:  
Voltage: 2 V  
Impedance: 1 kilohms  
SUBWOOFER AUDIO OUT:  
Voltage: 3 V  
Impedance: 47 kilohms  
PHONES:  
Accepts low- and high-impedance headphones

Outputs (Digital) DIGITAL OUT OPTICAL (CD ONLY):  
Sensitivity: –

## Super Audio CD/DVD system

Laser Semiconductor laser  
(Super Audio CD/DVD:  $\lambda = 650$  nm)  
(CD:  $\lambda = 780$  nm)  
Emission duration: continuous

Signal format system NTSC/PAL

Frequency response (at 2 CH STEREO mode)  
DVD (PCM): 2 Hz to 22 kHz ( $\pm 1.0$  dB)  
CD: 2 Hz to 20 kHz ( $\pm 1.0$  dB)

Signal-to-noise ratio More than 80 dB (VIDEO 1 (AUDIO) connectors only)

Harmonic distortion Less than 0.03 %

## FM tuner section

System	PLL quartz-locked digital synthesizer system
North American model:	87.5 – 108.0 MHz (100 kHz step)
Other models:	87.5 – 108.0 MHz (50 kHz step)
Antenna	FM wire antenna
Antenna terminals	75 ohms, unbalanced
Intermediate frequency	10.7 MHz

## AM tuner section

System	Tuner section: PLL quartz-locked digital synthesizer system
Tuning range	
North American model:	530 – 1,710 kHz (with the interval set at 10 kHz) 531 – 1,710 kHz (with the interval set at 9 kHz)
European, Middle Eastern, and Philipinne models:	531 – 1,602 kHz (with the interval set at 9 kHz)
Other models:	531 – 1,602 kHz (with the interval set at 9 kHz) 530 – 1,710 kHz (with the interval set at 10 kHz)
Antenna	Loop antenna
Intermediate frequency	450 kHz

## Video section

Inputs	S-video: Y: 1 Vp-p 75 ohms C: 0.286 Vp-p 75 ohms
Outputs	S-video: Y: 1 Vp-p 75 ohms C: 0.286 Vp-p 75 ohms

## General

Power requirements	230 V AC, 50/60 Hz
Power consumption	105 W
Dimensions (approx.)	430 × 82.5 × 376 mm (17 × 3 1/4 × 14 7/8 inches) (w/h/d) incl. projecting parts
Mass (approx.)	4.3 kg (9 lb 8 oz)
Operating temperature	5°C to 35°C (41°F to 95°F)
Operating humidity	5 % to 90 %
Supplied accessories	See page 15.

Design and specifications are subject to change without notice.

# Language Code List

For details, see pages 44, 52, 65.

The language spellings conform to the ISO 639: 1988 (E/F) standard.

Code Language	Code Language	Code Language	Code Language
1027 Afar	1183 Irish	1347 Maori	1507 Samoan
1028 Abkhazian	1186 Scots Gaelic	1349 Macedonian	1508 Shona
1032 Afrikaans	1194 Galician	1350 Malayalam	1509 Somali
1039 Amharic	1196 Guarani	1352 Mongolian	1511 Albanian
1044 Arabic	1203 Gujarati	1353 Moldavian	1512 Serbian
1045 Assamese	1209 Hausa	1356 Marathi	1513 Siswati
1051 Aymara	1217 Hindi	1357 Malay	1514 Sesotho
1052 Azerbaijani	1226 Croatian	1358 Maltese	1515 Sundanese
1053 Bashkir	1229 Hungarian	1363 Burmese	1516 Swedish
1057 Byelorussian	1233 Armenian	1365 Nauru	1517 Swahili
1059 Bulgarian	1235 Interlingua	1369 Nepali	1521 Tamil
1060 Bihari	1239 Interlingue	1376 Dutch	1525 Telugu
1061 Bislama	1245 Inupiak	1379 Norwegian	1527 Tajik
1066 Bengali; Bangla	1248 Indonesian	1393 Occitan	1528 Thai
1067 Tibetan	1253 Icelandic	1403 (Afan)Oromo	1529 Tigrinya
1070 Breton	1254 Italian	1408 Oriya	1531 Turkmen
1079 Catalan	1257 Hebrew	1417 Punjabi	1532 Tagalog
1093 Corsican	1261 Japanese	1428 Polish	1534 Setswana
1097 Czech	1269 Yiddish	1435 Pashto; Pushto	1535 Tonga
1103 Welsh	1283 Javanese	1436 Portuguese	1538 Turkish
1105 Danish	1287 Georgian	1463 Quechua	1539 Tsonga
1109 German	1297 Kazakh	1481 Rhaeto- Romance	1540 Tatar
1130 Bhutani	1298 Greenlandic	1482 Kirundi	1543 Twi
1142 Greek	1299 Cambodian	1483 Romanian	1557 Ukrainian
1144 English	1300 Kannada	1489 Russian	1564 Urdu
1145 Esperanto	1301 Korean	1489 Russian	1572 Uzbek
1149 Spanish	1305 Kashmiri	1491 Kinyarwanda	1581 Vietnamese
1150 Estonian	1307 Kurdish	1495 Sanskrit	1587 Volapük
1151 Basque	1311 Kirghiz	1498 Sindhi	1613 Wolof
1157 Persian	1313 Latin	1501 Sangho	1632 Xhosa
1165 Finnish	1326 Lingala	1502 Serbo-Croatian	1665 Yoruba
1166 Fiji	1327 Laothian	1503 Singhalese	1684 Chinese
1171 Faroese	1332 Lithuanian	1505 Slovak	1697 Zulu
1174 French	1334 Latvian; Lettish	1506 Slovenian	
1181 Frisian	1345 Malagasy		1703 Not specified

# DVD Setup Menu List

You can set the following items with the DVD setup menu.  
The order of the displayed items may be different from the actual display.

## LANGUAGE SETUP

- OSD — (Select the language you want to use from the displayed language list.)
- DVD MENU — (Select the language you want to use from the displayed language list.)
- AUDIO — (Select the language you want to use from the displayed language list. When you select ORIGINAL, you can enjoy the language given priority on the disc.)
- SUBTITLE — (Select the language you want to use from the displayed language list. When you select AUDIO FOLLOW, the setting is automatically switched to the language selected in AUDIO.)

## CUSTOM SETUP

- COLOR SYSTEM\* — AUTO, PAL, NTSC
- PAUSE MODE — AUTO, FRAME
- PARENTAL CONTROL — LEVEL — OFF, 8., 7. NC17, 6. R, 5., 4. PG13, 3. PG, 2., 1. G, STANDARD — USA, OTHERS, CHANGE PASSWORD
- TRACK SELECTION — OFF, AUTO

## SCREEN SETUP

- TV TYPE — 16:9, 4:3 LETTER BOX, 4:3 PAN SCAN
- SCREEN SAVER — ON, OFF
- BACKGROUND — JACKET, PICTURE, GRAPHICS, BLUE, BLACK

## SPEAKER SETUP

- SIZE — FRONT — LARGE, SMALL; CENTER — LARGE, SMALL, NONE; REAR — LARGE — BEHIND,LOW, BEHIND,HIGH, SIDE,LOW, SIDE,HIGH; SMALL — BEHIND,LOW, BEHIND,HIGH, SIDE,LOW, SIDE,HIGH; NONE
- SUBWOOFER — YES/NONE
- DISTANCE\*\* — FRONT — 1m ~15m; CENTER — 0m ~15m; REAR — 0m ~15m
- BALANCE — FRONT — 6 steps left or right; REAR — 6 steps left or right
- LEVEL — CENTER — -10dB ~ +10dB; REAR — -10dB ~ +10dB; SUBWOOFER — -10dB ~ +10dB
- TEST TONE — OFF, ON

\* Only for Asian models.



# Index

## Numerics

- 16:9 65
- 4:3 LETTER BOX 25
- 4:3 PAN SCAN 65

## A

- ADVANCED 53
- AMP MENU 24
- ANGLE 51
- Antenna Hookups 19
- AUDIO 44, 64

## B

- BACKGROUND 66
- BALANCE 26, 69
- BAND 28
- Batteries 16
- Bit rate 53, 74

## C

- CD 30
- CHAPTER 39
- Chapter 6, 74
- COLOR SYSTEM 66
- Continuous play
  - CD/VIDEO CD/Super Audio
  - CD/DVD 30
- Control Menu 13
- CUSTOM PARENTAL CONTROL 54
- CUSTOM SETUP 66

## D

- DIMMER 27
- DISTANCE 25, 68
- Dolby Digital 74
- Dolby Pro Logic Surround 75
- DTS 75
- DVD 32, 75
- DVD MENU 32, 64

## F

- Front Panel 9
- Fast forward 38
- Fast reverse 38
- Front panel display 10

## H

- Handling discs 8

## I

- INDEX 39
- Index 6

## L

- LANGUAGE SETUP 64
- LEVEL 27, 69
- Locating
  - a specific Point 39
  - by watching the TV screen 38

## M

- MEMORY 28
- Multi-angle function 51
- Multilingual function 44
- MUTING 31

## N

- NAME 62

## O

- On-screen display
  - Control Menu display 13
  - Setup Display 63
- OSD 64

## P

- PARENTAL CONTROL 55, 67, 75
- PAUSE MODE 67
- PBC Playback 33, 75
- PLAY MODE 34
- Preset Station 28, 61
- Programme Play 34

## Q

- Quick Overview 15

## R

- Radio 61
- Rear Panel 11
- Region code 7, 76
- Remote 12, 59
- REPEAT 36
- RESET 64
- Resume Play 31

## S

- S VIDEO 21
- Super Audio CD 76
- Scan 38
- SCENE 39
- Scene 6, 76
- SCREEN SAVER 66
- SCREEN SETUP 65
- SHUFFLE 36
- Shuffle Play 36
- SIZE 67
- Slow-motion Play 38
- Sound Field 46
- SPEAKER SETUP 67
- Speaker System Hookup 16
- SUBTITLE 52, 64

## T

- TEST TONE 69
- TIME SEARCH 40
- TIME 41
- TIME/TEXT 40
- TITLE 39
- Title 6, 76
- Title menu 32
- TRACK 39
- Track 6, 76
- TRACK SELECTION 67
- Troubleshooting 71
- TV Hookups 21
- TV TYPE 65

## U

- Usable discs 6

## V

- VIDEO CD 33, 76

## 警語

為防止火災或電擊，請勿將本機放在雨水所及或潮濕的地方。

請勿將本機安裝在狹窄的空間內，如書櫥或壁櫥內。

為防止火災，切勿用報紙、桌布、窗簾等蓋住設備的通風孔。也不要將點燃的蠟燭放在設備上。

為防止火災或電擊，請勿將花瓶等裝滿液體的物品放在設備上。

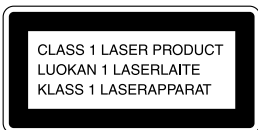

本設備被分類為 CLASS 1 LASER 產品。此標籤位於設備的後表面。

下列警告標籤位於接收器內。



勿將電池與普通的家庭垃圾一起扔棄，請將其作為化學廢棄物正確地處理。

## 注意事項 安全

- 若有任何異物掉落到機殼內，請拔下本機電源插頭，並經合格的專業技術人員檢查以後，方可再行使用。
- 即使本機電源已關閉，但祇要電源線還插在牆壁電源插座上，則仍未脫離交流電源。
- 如果您長期不使用本機，請從牆壁電源插座拔下電源線。拔取電源線時，請拿著插頭拔出，切勿拉扯電線。

## 安裝

- 請保持空氣流通以防止機內積熱。
- 請勿將本機放在柔軟的表面（如毛毯、地毯等），或靠近窗簾、帷幔等物，以免阻塞通風孔。
- 請勿將本機放在靠近如散熱器或排氣管等熱源之處，或受陽光直射、多塵、有機械振動或衝擊的地方。
- 請勿將本機傾斜放置。本機必須在水平位置上工作。
- 請勿將本機和光碟放在帶強磁場的裝置附近，如微波爐或大功率揚聲器。
- 請勿在本機上放置重物。
- 如果將本機直接從寒冷的地方搬到溫暖的地方，會引起壓縮 AV 接收機內部出現濕氣凝結，並損壞透鏡。當您第一次使用本機時，或將其從寒冷地方直接搬到溫暖的地方使用時，請等待約 30 分鐘以後再開始操作。



ENERGY STAR® 是美國註冊商標。

作為 ENERGY STAR® 的伙伴，Sony 公司已經確定本產品符合 ENERGY STAR® 能量效率準則。

## 歡迎使用！

感謝您購買 Sony 壓縮 AV 接收機。在操作本接收機前，請仔細閱讀本手冊，並妥善保管，以備今後參考。

# 注意事項

## 關於安全

如果有固體物品或者液體落入機箱，請拔下插頭，並請合格的技術人員檢修，此前請勿繼續使用。

## 關於電源

- 只要本機仍連接在牆上的電源插座內，即使機器已經關閉，但本機仍未脫離交流電源。
- 交流電源線只能在有資格的服務商店進行更換。

## 關於放置

- 接收機應放置於通風良好的地方，以防止接收機內部熱量的聚積。
- 長時間以大音量使用將導致機殼發熱。這不是故障。但是，請勿觸摸機殼。勿將本裝置放置在通風不良的狹窄之處，以防止過熱。
- 切勿在該接收機上放置任何物體，以免阻塞通風孔。本接收機裝有一個大功率放大器。如果上表面的通風孔被阻塞，將導致本裝置過熱並產生故障。
- 勿將接收機放置於地毯之類的柔軟表面上，以防止堵塞住底部的通風孔。
- 勿將接收機放置於熱源附近，或受陽光直接照射，或是過多灰塵的地方，或者遭受機械沖擊。

## 關於操作

- 如果接收機直接從較冷的地方移到較暖的地方，或者放置於潮濕的房間中，接收機內部的鏡頭上可能有水汽凝結。如果這樣，接收機可能無法正常工作。這種情況下，可取出光碟，並使接收機通電約半小時，直至水汽蒸發。
- 當移動接收機時，須取出光碟。否則，可能會損壞光碟。
- 為了節約能源，可用主機上的 POWER 按鈕完全關閉該接收機。雖然 LED 繼續點亮片刻，但是接收機已被完全關閉。

## 關於音量調節

當聽到音量較小或沒有聲音信號的部分時，不要增加音量。否則，在播放到峰值信號部分時可能會損壞揚聲器。

## 關於清潔

用蘸有清潔劑溫水溶液的軟布清潔機箱、面板以及各控制鍵。不要使用任何粗糙的布、洗衣粉，或者溶劑如酒精或汽油。

如果您對接收機有什麼疑問或問題，請向當地的 Sony 產品銷售商諮詢。

## 關於清潔光碟

切勿使用市面上購買的 CD/DVD 清潔光碟。這可能會導致故障發生。

## 關於您的電視機的顏色

如果揚聲器引起電視機屏幕顏色不正常，請立即關閉電視機，15 - 30 分鐘之後再打開電視機。如果情況未能改善，請將揚聲器遠離電視機。

### 重要注意事項

注意：本接收機會在您的電視機屏幕上產生不確定的靜止視頻圖像或屏幕顯示圖像。如果您在電視機屏幕上長時間保留這些圖像，將有可能對您的電視機屏幕造成永久損傷。投影電視機特別容易受到此類損傷。

# 目錄

警語	2
歡迎使用！	2
注意事項	3
關於本手冊	6
本接收機可以播放的光碟	6
光碟使用注意事項	8
部件和控制鍵索引	9
控制選單顯示說明（魔板）	13
<hr/>	
<b>入門指南</b>	<b>15</b>
快速瀏覽	15
開箱	15
遙控器電池的安裝	16
步驟 1：揚聲器系統的連接	16
步驟 2：天線連接	19
步驟 3：電視機與視頻部件連接	21
揚聲器設定	23
預設電台	28
<hr/>	
<b>播放光碟</b>	<b>30</b>
播放光碟	30
從停止的地方恢復播放光碟（恢復播放）	31
使用 DVD 選單	32
用 PBC 功能播放 VIDEO CD 光碟（PBC 播放）	33
創建自己的程序（編序播放）	34
隨機播放（隨機播放）	36
反覆播放（重複播放）	36
<hr/>	
<b>搜尋場面</b>	<b>38</b>
搜尋光碟上的特定位置（掃描，慢速播放）	38
搜尋標題/章/軌跡/索引/場面	39
<hr/>	
<b>瀏覽光碟資訊</b>	<b>41</b>
瀏覽前面板顯示幕上的播放時間和剩餘時間	41
查看播放時間和剩餘時間	42

<b>聲音調節</b>	44
改變聲音	44
自動解碼音頻輸入信號	46
欣賞環繞聲	46
僅使用前置揚聲器	50
調節音量等級參數	50
<b>欣賞電影</b>	51
變換角度	51
顯示字幕	52
查看播放資訊（先進功能）	53
<b>使用各種附加功能</b>	54
鎖住碟片（用戶鎖定，視聽者年齡控制）	54
<b>其他操作</b>	59
用遙控器控制電視機	59
觀看圖像或其它裝置	60
收聽無線電台	61
為預置電台命名	62
<b>設定和調節</b>	63
使用設定顯示	63
設定顯示或聲音軌跡語言（語言設定）	64
顯示設定（畫面設定）	65
個人設定（個人設定）	66
揚聲器的設定（揚聲器設定）	67
<b>附加資訊</b>	71
故障排除	71
自檢功能（顯示中出現字母/數字時）	74
術語	74
規格	77
語言代碼列表	79
DVD 設定選單列表	80
索引	81

# 關於本手冊

- 本手冊中的說明採用遙控器上的控制鍵。如果在接收機上有與遙控器上相同或相似名稱的控制鍵，您也可以使用。
- 本手冊中使用的圖形標誌解釋如下：

標誌	含義	標誌	含義
	DVD 視頻模式中可用的功能		Super Audio CD (超級音頻 CD) 和音頻 CD 模式中可用的功能
	VIDEO CD 模式中可用的功能		CD 模式中可用的功能
			更多的方便特色

# 本接收機可以播放的光碟

光碟格式	
DVD VIDEO	
超級音頻 CD	
VIDEO CD	
音樂 CD	

“DVD VIDEO” 標識是一個商標。

## 光碟術語

- **標題**  
在 DVD 光碟、電影，以及視頻軟件中，最長的畫面或音樂特輯部分；在視頻軟體上的電影等畫面片段；或者在音頻軟體上的整個專輯等。每個標題配有一個標題號碼，可用來查找您想要的標題。
- **章**  
比標題小的一段畫面或一段音樂部分。一個標題由幾個章組成。每個章都分配有一個章號，可以使您查找到您想要的章。根據光碟的不同，章可不被標記號碼。
- **軌跡**  
VIDEO CD、Super Audio CD 或 CD 光碟上一段畫面或一段音樂作品中的一部分。每個曲目都分配有一個軌跡號，可以使您查找到您想要的軌跡。
- **索引 (Super Audio CD, CD) / 視頻索引 (VIDEO CD)**  
VIDEO CD、Super Audio CD 或 CD 上將一個軌跡分成幾部分的數字，以使您方便地查找到您想要的位置。根據光碟的不同，有些可能未錄製索引。
- **場面**  
在有 PBC 功能 (第 33 頁) 的 VIDEO CD 光碟上，選單屏幕、運動的畫面和靜止的畫面被分成幾部分，每部分稱作“場面”。每個場面都分配有一個場面號，可以使您查找到您想要的場面。

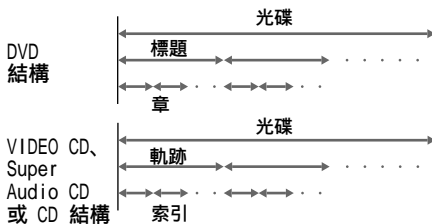

## PBC (播放控制) 注意事項 (VIDEO CD 光碟)

本接收機符合 VIDEO CD 標準 1.1 版本和 2.0 版本。您可以根據光碟的種類來體驗兩種不同的類型播放。

光碟種類	您可以
無 PBC 功能的 VIDEO CD 碟 (1.1 版本光碟)	欣賞視像 (運動畫面) 及音樂
有 PBC 功能的 VIDEO CD 光碟 (2.0 版本光碟)	除 1.1 版本光碟的視頻播放功能外, 還可以通過電視機屏幕上顯示的選單屏幕來播放交互式軟體。此外, 您也可以播放光碟上的高分辨率靜止畫面。

## 地區代碼

您的接收機在裝置後部印有一個地區代碼, 接收機只能播放標有相同地區代碼的 DVD 光碟。

標有  的 DVD 光碟也可以在本接收機上使用。

如果您試圖播放其它類型的 DVD 光碟, 電視機屏幕上將顯示“由於地區限制, 此光碟禁止播放。”的資訊。有些 DVD 光碟可能沒有標上地區代碼, 但由於受地區限制無法播放。

## 接收機不能播放的光碟舉例

接收機不能播放以下光碟:

- CD - ROM (包括 PHOTO CD)
- 除了音樂和 VIDEO CD 格式的 CD - R 以外的所有 CD - R
- CD - Extra 的數據部分
- DVD - ROM
- DVD 音頻光碟
- 有不同地區代碼的 DVD 光碟 (第 7、75 頁)
- 非標準外形的光碟 (例如卡片形、心形)
- 貼有紙或膠粘物的光碟
- 表面有膠合劑、玻璃紙膠帶, 或膠粘物的光碟

### 注意

由於光碟刻錄的品質或物理條件的不同, 或是刻錄設備的性能不同, 本接收機上將不能播放某些 CD - R 或 CD - RW 光碟。

此外, 如果光碟未正確錄製完成, 也將不能播放。更多資訊請查閱刻錄設備的操作說明。

## DVD 光碟和 VIDEO CD 光碟的播放操作注意事項

某些 DVD 光碟和 VIDEO CD 光碟的播放操作可能由軟體製造商特意設置。由於本接收機按照軟體製造商設計的光碟內容播放 DVD 光碟和 VIDEO CD 光碟, 某些播放性能可能不能使用。同樣, 可以查閱 DVD 光碟和 VIDEO CD 光碟所附帶的說明。

## 著作權

本產品含有著作權保護技術，受美國專利法權保護，其它技術所有權歸 Macrovision 公司及其它權利所有者所有。須經 Macrovision 公司授權方可使用此著作權保護技術，並僅限於家庭用及其它有限的觀賞用途，除非經 Macrovision 公司額外授權。禁止顛倒操縱和拆裝。

本接收機含有 Dolby\* Digital、Pro Logic 環繞、及 DTS\*\* 數字環繞系統。

\* 經杜比實驗室授權生產。

“杜比”，“Dolby”，“Pro Logic”和雙 D 標誌是杜比實驗室的商標。不予發行的保密作品。© 杜比實驗室 1992 - 1997 年。版權所有，翻印必究。

\*\* Digital Theater Systems 公司美國專利號 5, 451, 942，以及其它世界範圍內的在申請中並未得到答覆的專利所許可下的生產。“DTS”和“DTS Digital Surround”是 Digital Theater Systems 公司的商標。© 1996 Digital Theater Systems 公司版權所有。

## 光碟使用注意事項

### 關於拿取光碟

- 為保持光碟清潔，夾住邊緣拿取光碟，切勿觸摸光碟的表面。
- 不要在光碟上粘貼紙張或膠帶紙。



- 不要讓光碟處於陽光直接照射下，或者暖氣管等熱源的附近，或者留在陽光照射下的汽車內，以免車內的溫度升高而對光碟造成損害。
- 播放完後，請將光碟置於光碟盒內保存。

### 關於清潔

- 播放前，用乾淨的布清潔光碟。從光碟的中心向外緣擦拭。



- 請勿使用汽油、稀釋劑等溶劑，或者是市面上購買的清潔劑，或者是抗靜電噴霧劑聚乙烯。



# 部件和控制鍵索引

更多資訊，請參考括號中標註的頁。

## 前面板

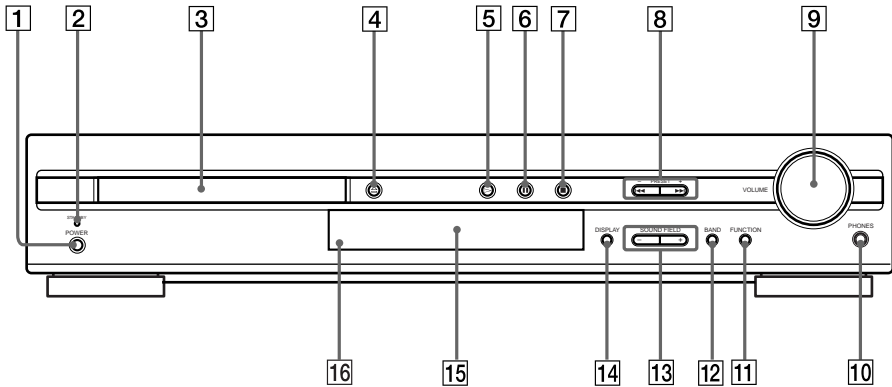

- |   |                                       |
|---|---------------------------------------|
| <b>1</b> POWER (電源) 開關 (30)                   | <b>10</b> PHONES (耳機) 插孔 (30)         |
| <b>2</b> STANDBY (等待) 指示燈 (30)                | <b>11</b> FUNCTION (功能) 鍵 (60)        |
| <b>3</b> 光碟托架 (30)                            | <b>12</b> BAND (波段) 鍵 (28)            |
| <b>4</b> 合 (打開/關閉) 鍵 (30)                     | <b>13</b> SOUND FIELD +/- (聲場) 鍵 (46) |
| <b>5</b> ▷ (播放) 鍵 (30)                        | <b>14</b> DISPLAY (顯示) 鍵 (61)         |
| <b>6</b>    (暫停) 鍵 (31)                       | <b>15</b> 前面板顯示幕 (10)                 |
| <b>7</b> ■ (停止) 鍵 (30)                        | <b>16</b> □ (遙控器感應器) (16)             |
| <b>8</b> ◀◀/▶▶ PRESET +/- (預置 +/-) 鍵 (28, 31) |                                       |
| <b>9</b> VOLUME 控制器 (30)                      |                                       |

## 前面板顯示幕

### 播放 DVD 光碟時

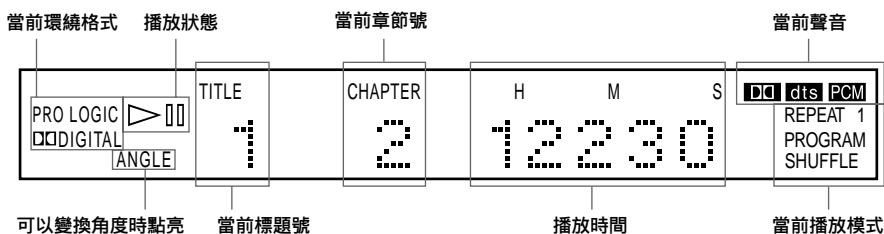

### 播放 Super Audio CD、CD 或 VIDEO CD 光碟時

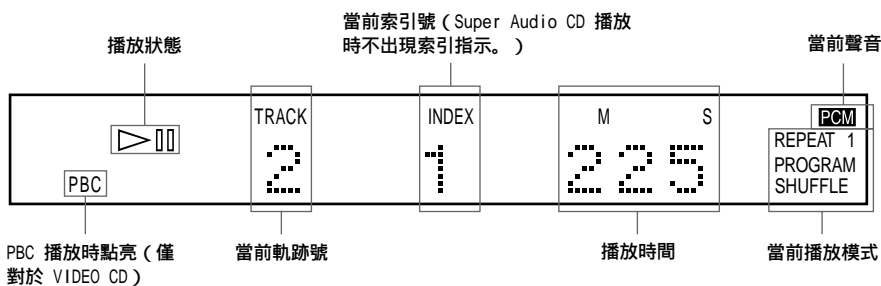

### 收聽無線電台時

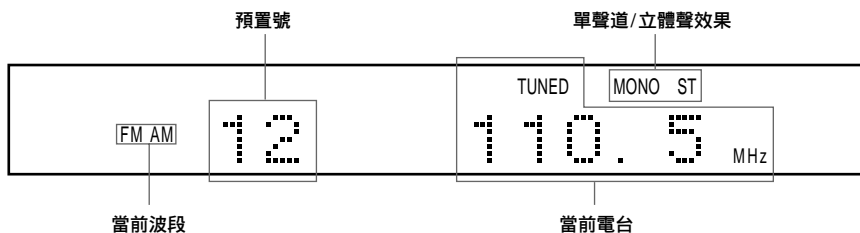

## 後面板

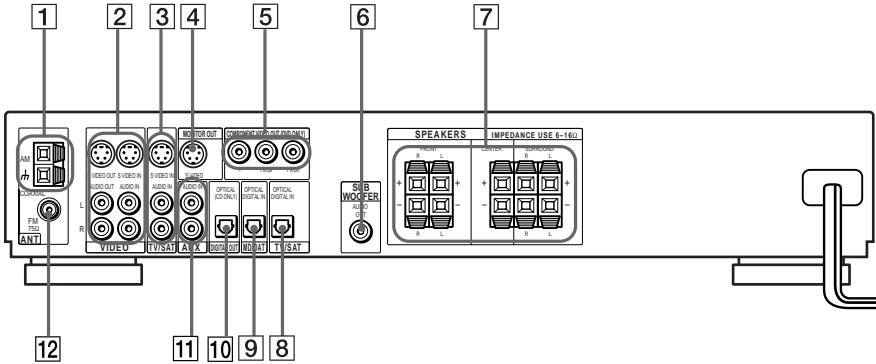

- |   |   |
|---|---|
| <p><b>1</b> AM 天線 (19)</p> <p><b>2</b> VIDEO (S VIDEO/AUDIO L/R OUT/IN) 插孔 (21)</p> <p><b>3</b> TV/SAT (S VIDEO/AUDIO L/R IN) 插孔 (21)</p> <p><b>4</b> MONITOR OUT (S VIDEO) 插孔 (21)</p> <p><b>5</b> COMPONENT VIDEO OUT 插孔 (21)</p> | <p><b>6</b> SUBWOOFER AUDIO OUT 插孔 (17)</p> <p><b>7</b> SPEAKERS 插孔 (17)</p> <p><b>8</b> TV/SAT (OPTICAL DIGITAL IN) 插孔</p> <p><b>9</b> MD/DAT (OPTICAL DIGITAL IN) 插孔</p> <p><b>10</b> DIGITAL OUT (OPTICAL (CD ONLY)) 插孔</p> <p><b>11</b> AUX (AUDIO IN L/R) 插孔</p> <p><b>12</b> FM 75Ω COAXIAL 天線插孔 (20)</p> |
|---|---|

## 遙控器

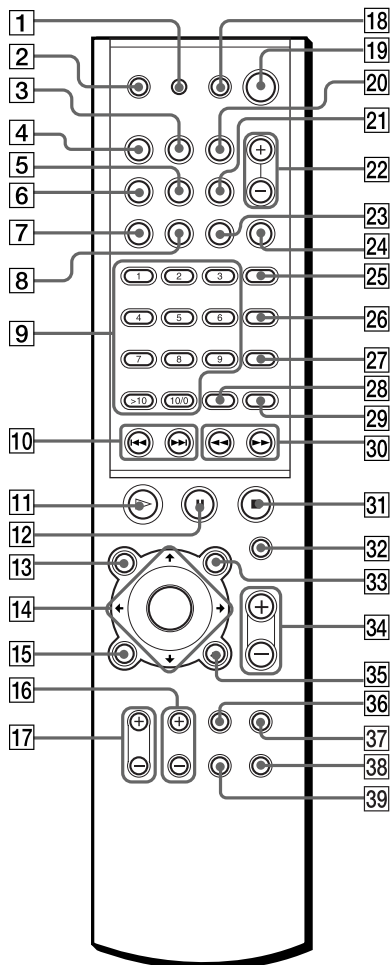

### 注意

此遙控器在黑暗中會發光。不過，此前應將遙控器置於光線下照射一段時間。

- 1 RM SET UP (RM 設定) 鍵 (59)
- 2 OPEN/CLOSE (打開/關閉) 鍵 (30)
- 3 BAND (波段) 鍵 (28)
- 4 FUNCTION (功能) 鍵 (60)
- 5 MEMORY (記憶) 鍵 (28)
- 6 NAME (名稱) 鍵 (63)
- 7 PLAY MODE (播放模式) 鍵 (34)
- 8 REPEAT (重複) 鍵 (37)
- 9 號碼鍵 (32)
- 10 ◀◀/▶▶ PRESET +/- (預置 +/-) 鍵 (28, 31)
- 11 ▷ (播放) 鍵 (30)
- 12 ■ (暫停) 鍵 (31)
- 13 DVD TOP MENU (DVD 頂部選單) 鍵 (32)
- 14 ←/↑/↓/→/ENTER (←/↑/↓/→ 確認) 鍵 (24)
- 15 DVD DISPLAY (DVD 顯示) 鍵 (13, 26)
- 16 TV CH +/- 鍵 (60)
- 17 TV VOL +/- (音量 +/-) 鍵 (60)
- 18 TV I/⏻ (開啟/待機) 鍵 (60)
- 19 I/⏻ (開啟/待機) 鍵 (30)
- 20 STEREO/MONO (立體聲/單聲道) 鍵 (61)
- 21 DISPLAY (顯示) 鍵 (61)
- 22 SOUND FIELD +/- (聲場) 鍵 (46)
- 23 TIME (時間) 鍵 (41)
- 24 DIMMER (調光器) 鍵 (27)
- 25 AUDIO (音頻) 鍵 (44)
- 26 ANGLE (角度) 鍵 (51)
- 27 SUBTITLE (字幕) 鍵 (52)
- 28 ENTER (確認) 鍵
- 29 CLEAR (清除) 鍵 (35)
- 30 ◀◀/▶▶ 鍵 (28, 38)
- 31 ■ (停止) 鍵 (30)
- 32 MUTING (靜音) 鍵 (31)
- 33 DVD MENU (DVD 選單) 鍵 (32)
- 34 VOLUME +/- (音量 +/-) 鍵 (30)
- 35 ↶ RETURN (返回) 鍵 (33)
- 36 TV/VIDEO (TV/視頻) 鍵 (60)
- 37 AMP MENU (AMP 選單) 鍵 (24)
- 38 DVD SETUP (DVD 設置) 鍵 (64)
- 39 WIDE (寬屏幕) (60)





# 控制選單顯示說明 (魔板)

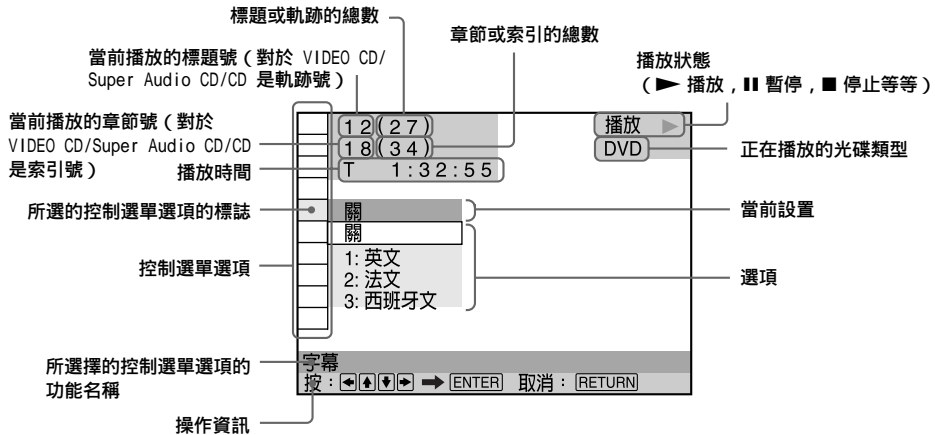





使用控制選單可以選擇您想實現的功能。按下 DVD DISPLAY 鍵可以顯示控制選單。更多資訊請參閱括號中標註的相應頁。

## 控制選單



## 控制選單選項列表



 <b>標題 (僅對於 DVD) (第 39 頁) / 場面 (僅對於 PBC 播放時的 VIDEO CD) (第 39 頁) / 軌跡 (僅對於 VIDEO CD) (第 39 頁)</b>	可以播放所選擇的標題 (DVD), 場面 (PBC 播放時的 VIDEO CD), 或者軌跡 (VIDEO CD)。
 <b>章 (僅對於 DVD) (第 39 頁) / 索引 (僅對於 VIDEO CD) (第 39 頁)</b>	可以播放所選擇的章 (DVD), 或者索引 (VIDEO CD)。
 <b>軌跡 (僅對於 Super Audio CD/CD) (第 39 頁)</b>	可以播放所選擇的軌跡 (Super Audio CD/CD)。
 <b>索引 (僅對於 Super Audio CD/CD) (第 39 頁)</b>	可以播放所選擇的索引 (Super Audio CD/CD)。
 <b>時間/文字 (第 40 頁)</b>	查看已用的時間和所剩播放時間。輸入時間代碼可以進行畫面和音樂的搜索。顯示 DVD 或 Super Audio CD/CD 光碟的文字內容。

	聲音語言 (第 44 頁)	改變音頻設置。
	字幕 (僅對於 DVD) (第 52 頁)	顯示字幕。 改變字幕的語言。
	角度 (僅對於 DVD) (第 51 頁)	改變角度。
	重複 (第 36 頁)	重複播放整個光碟 (所有的標題/所有的軌跡), 或者重複播放一個標題/章/軌跡。
	先進功能 (僅對於 DVD) (第 53 頁)	播放 DVD 時查看光碟上的資訊 (比特速率或層)。
	用戶鎖定 (第 54 頁)	設置光碟為禁止播放狀態。
	設定 (第 64 頁)	個人設定 使用設置顯示, 您可以調整畫面和聲音等各種選項。您也可以在其他選項中設置字幕和設置顯示的語言。 重新設定 在“設定”中將設置恢復至默認狀態。

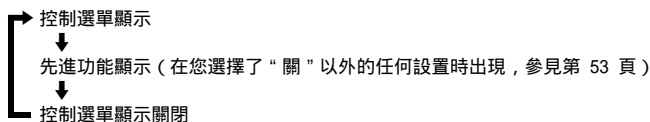
 當您每按一次 DVD DISPLAY 鍵, 控制選單的顯示按如下變化:



控制選單選項因光碟不同而有差異。

 當您選擇了除“關”以外的“重複”時, 控制選單標誌指示燈變綠。  →  僅當角度可以變化時, “角度”指示燈變綠。

## 快速瀏覽

本章提供了一個快速瀏覽方式，使您可以迅速使用您的新接收機。  
要選擇屏幕顯示中使用的語言，參閱第 64 頁。  
要選擇所連接的電視機上的外觀比例，參閱第 65 頁。

## 開箱

檢查以下組件：

- 調幅環形天線 (1)
- 調頻纜線天線 (1)
- S 視頻線 (1)
- 遙控器 RM-SP10 (1)
- R6 (型號 AA) 電池 (2)

## 遙控器電池的安裝

您可以使用提供的遙控器控制接收機。裝入兩節 R6 (型號 AA) 電池，注意電池的 ⊕ 和 ⊖ 極要與電池盒內的標誌一致。使用遙控器時，要將遙控器對準接收機上的遙控感應器 。

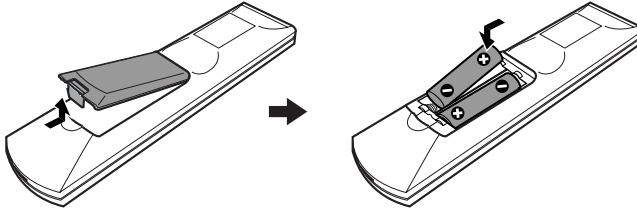

### 注意

- 請勿將遙控器置於過熱或過於潮濕的地方。
- 請勿將新電池與舊電池混用。
- 遙控器內切勿落入異物，尤其在更換電池時。
- 請勿讓陽光或發光的物品直接照射遙控感應器。否則可能會引起故障。
- 長期不用遙控器時請取出電池，以免因電池洩漏和腐蝕可能引起的損害。

## 步驟 1：揚聲器系統的連接

您可以通過將 5 個揚聲器（前置左 / 右揚聲器，中置揚聲器，後置左 / 右揚聲器）和有源低音揚聲器連接至本接收機來欣賞環繞聲。如果您未在接收機上連接 5 個揚聲器和有源低音揚聲器，接收機則根據連接的揚聲器數量優化環繞信號。在接收機上連接 2 個揚聲器時，請將揚聲器連接至 SPEAKERS FRONT L/R 插孔。

### 注意

- 務必將揚聲器導線連接至合適的端子：⊕ 至 ⊕，⊖ 至 ⊖，L 至 L，以及 R 至 R 插孔。
- 請使用高性能的揚聲器。
- 請使用同一尺寸和性能的前置，中置和後置揚聲器。
- 要獲得盡可能好的環繞聲，請指定第 23 頁中的揚聲器參數（數量，距離，音量等級等）。



## 連接揚聲器的接線端

連接	連接到
前置揚聲器	SPEAKER FRONT L 和 R 接線端
後置揚聲器	SPEAKER REAR L 和 R 接線端
中置揚聲器	SPEAKER CENTER 接線端
低音揚聲器	SUBWOOFER AUDIO OUT 接線端

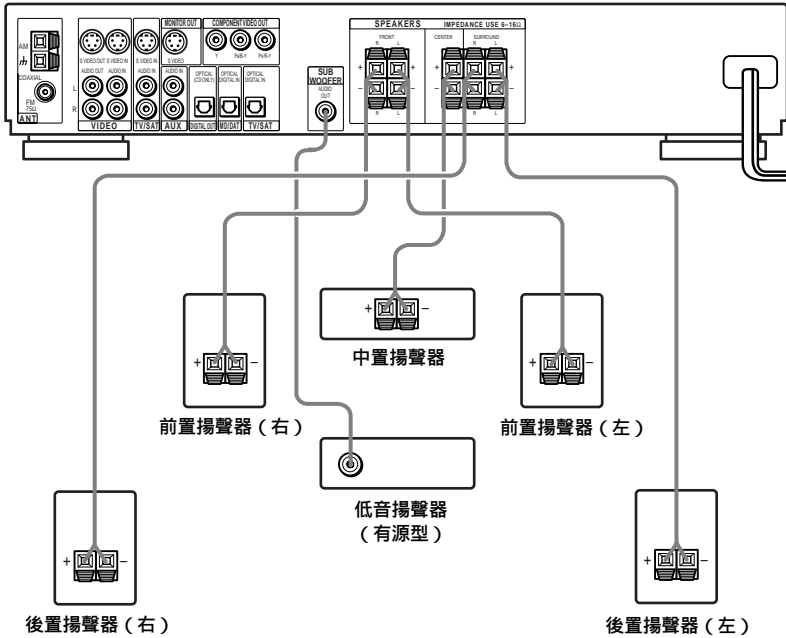

## 避免揚聲器短路

揚聲器短路可能會引起對接收機的損害。為避免出現這種情況，連接揚聲器時一定要遵循以下注意事項。每個揚聲器連線的電線裸露部分必須不能碰到其它揚聲器接線端或其它揚聲器連線的電線裸露部分。

### 揚聲器連線的錯誤情況舉例

揚聲器連線的電線裸露部分  
與其它揚聲器接線端接觸

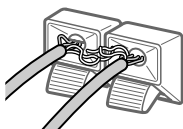

由於絕緣面移除而使電線裸露部分  
互相接觸

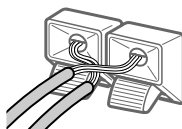

在連接完所有的組件、揚聲器和交流電源線（幹線導線）後，輸出一個測試聲音以檢測所有的揚聲器是否連接正確。輸出測試聲音的詳細說明請參閱第 26 頁。

如果輸出測試聲音時揚聲器中沒有聲音，或者播放出聲音的揚聲器不是前面板顯示幕內當前顯示的揚聲器，則揚聲器可能短路。這種情況下須重新檢查揚聲器的連接。

### 注意

- 揚聲器連線要與組件上正確的接線端相連接：⊕ 接 ⊕，⊖ 接 ⊖。如果連線接反，聲音將會失真及缺少低音部分。
- 如果您使用下限最大輸入額定功率的前置揚聲器，請小心調整音量，以免揚聲器上的輸出過大。

## 步驟 2：天線連接

連接上所提供的調幅/調頻天線以收聽無線電台。

### 連接天線所用的接線端

連接	連接到
調幅環形天線	調幅接線端
調頻線天線	調頻 75 同軸接線端

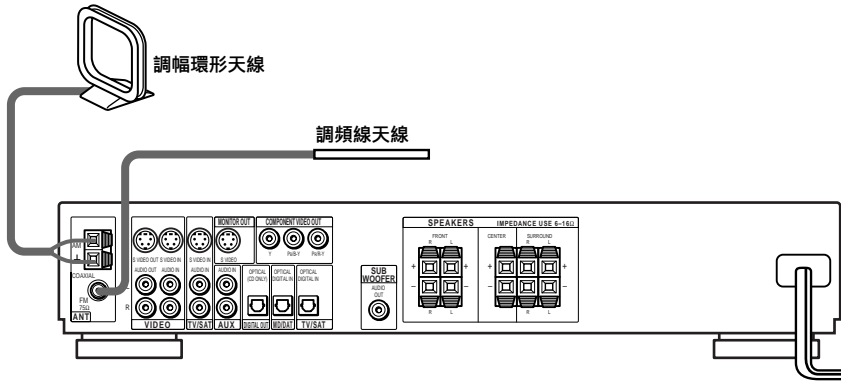

### 注意

- 為防止產生噪聲，可將調幅環形天線遠離接收機及其它組件。
- 須將調頻纜線天線充分伸展開。
- 連接完調頻線天線後，應盡可能地使它保持水平。

💡 如果調頻波段接收效果不佳

用— 75 的同軸電纜（未提供）將接收機與戶外的調頻天線相連接，如下圖所示。

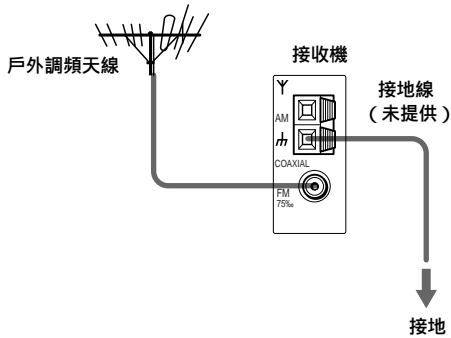

**注意**

如果您將接收機與戶外的調頻天線相連接，須將接收機接地以免遭到雷擊。為防止可燃氣體爆炸，切勿將接地線連接到煤氣管道上。

## 步驟 3：電視機與視頻部件連接

### 所需連線

連接電視顯示器的 S - 視頻線



音頻線（未提供）

連接接線時，務必要將各種顏色標記的插頭與組件上相應的插孔正確連接。



### 連接視頻組件的插孔

連接	連接到
電視顯示器	MONITOR OUT (S VIDEO) 插孔
錄像機	VIDEO (S VIDEO/AUDIO L/R IN/OUT) 插孔
數字衛星接收機	TV/SAT (S VIDEO/AUDIO L/R IN) 插孔

 當使用 COMPONENT VIDEO OUT 插孔 (Y, P<sub>B</sub>/C<sub>B</sub>, P<sub>R</sub>/C<sub>R</sub>) 取代 S 視頻插孔時，您的電視顯示器也必須連接到 COMPONENT VIDEO OUT 插孔 (Y, P<sub>B</sub>/C<sub>B</sub>, P<sub>R</sub>/C<sub>R</sub>)。

### 注意

- 當您使用 FUNCTION 鍵選擇 VIDEO 時，信號從前置左 / 右揚聲器輸出，而不是從 VIDEO (AUDIO L/R OUT) 插孔輸出。
- 當您使用視頻線 1 輸出時，請將該裝置設定為 2CH STEREO 模式。如果沒有將該裝置設定為 2CH STEREO 模式，線輸出可能無法正確進行。

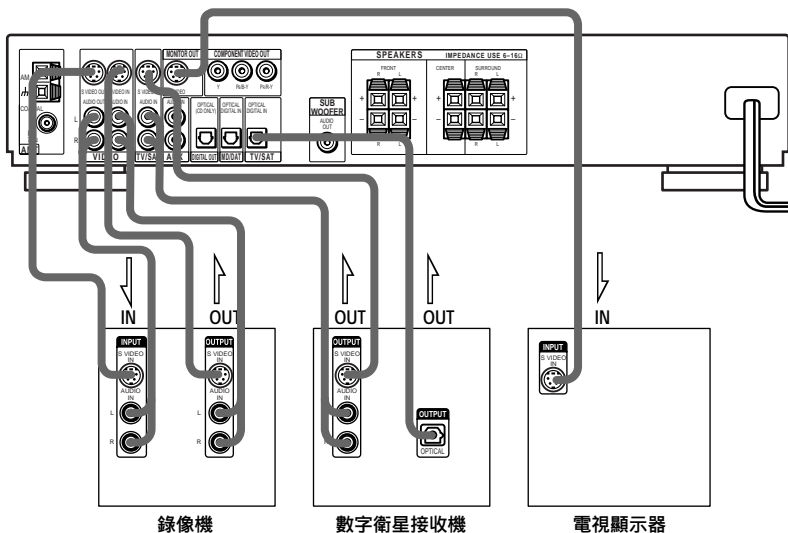

### 如果連接帶 TV/SAT (OPTICAL DIGITAL IN) 插孔的數字衛星接收機

將數字衛星接收機連接至接收機的 TV/SAT(OPTICAL DIGITAL IN)插孔，而不是 TV/SAT (AUDIO L/R IN)插孔。

接收機可以接收數字和模擬兩種信號。數字信號的優先級別高於模擬信號。如果數字信號中斷，2 秒鐘後接收機將處理模擬信號。

### 如果連接不帶 TV/SAT(OPTICAL DIGITAL IN)插孔的數字衛星接收機

數字衛星接收機只能連接至接收機的 TV/SAT (AUDIO L/R IN) 插孔。

## 接收機設定

根據連接的電視顯示器不同，有必要對接收機進行設定。

亞洲機型的初始設定為 NTSC。

### 如果電視機的彩色系統為 PAL\*

要將接收機設定為 PAL，按住接收機上的 **II**（暫停）鍵的同時按遙控器上的 **II/⏻** 鍵打開接收機電源。必須按住 **II** 鍵直至 AVD-S10 出現在顯示幕上。要重新設定為 NTSC，請先關閉接收機，然後按住接收機上的 **II** 鍵的同時用遙控器再次打開接收機電源。

\* 如果電視機的彩色系統為 NTSC，進行上述同樣的操作將接收機設定為 NTSC。

## 連接交流電源線（幹線導線）

在將接收機的交流電源線（幹線導線）接到牆上的插座（幹線）上之前，先要將揚聲器連接到接收機上（參閱第 17 頁）。

將電視機/視頻組件的交流電源線（幹線導線）接到牆上的插座（幹線）上。

## 揚聲器設定

為盡可能獲得最佳的環繞聲效果，除低音揚聲器外的所有揚聲器都應與收聽位置有相同的距離 (A)。

然而，如果需要，您可以將中置揚聲器向收聽位置移近 1.6 米 (B)，將後置揚聲器向收聽位置移近 4.6 米 (C)。

前置揚聲器可以放在距離收聽位置 1.0 - 15.0 米 (A) 的範圍內。

低音揚聲器可以放在任何位置上。

您可以根據房間的形狀等因素，將後置揚聲器放置於您的後方或是兩側。

後置揚聲器放置於兩側時

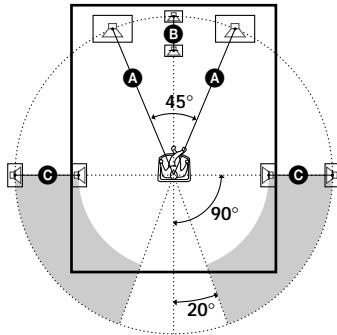

後置揚聲器放置於後方時

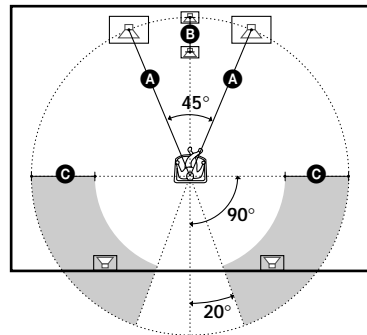

### 注意

中置揚聲器和後置揚聲器不要放置得比前置揚聲器距離收聽位置更遠。

### 揚聲器參數說明

為盡可能獲得最佳的環繞聲效果，首先規定揚聲器離開收聽位置的距離，然後設置平衡和音量等級。使用測試聲音調整揚聲器的音量至相同等級。

您可以在設定顯示中使用“揚聲器設定”來調整揚聲器的參數 (參閱第 67 頁)。

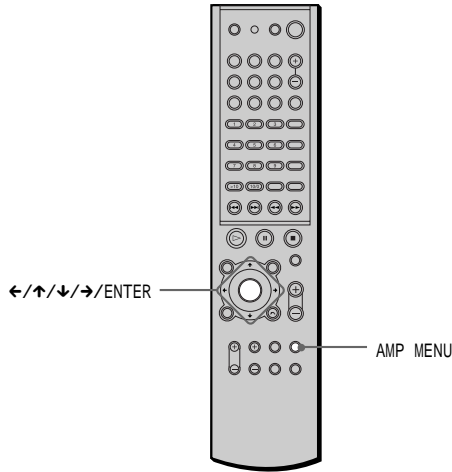

### 確定揚聲器的尺寸，距離，位置和高度

- 1 反覆按下 AMP MENU 鍵，直至前面板顯示幕內顯示 ♪ SP.SETUP。
- 2 坐在收聽位置上，使用 ↑/↓ 鍵來選擇所要設定的選項。
  - ♪ SP.SETUP 中設定的選項
    - 5 個揚聲器（前置左 / 右，中置，後置左 / 右）的尺寸
    - 帶有或沒有低音揚聲器
    - 前置揚聲器、後置揚聲器和中置揚聲器的距離
    - 後置揚聲器的位置和高度
- 3 使用 ←/→ 鍵來設定參數。  
所選擇的參數將出現在前面板顯示幕內。
- 4 重複步驟 2 和步驟 3，在 ♪ SP.SETUP 中設定其它參數。  
如果停止操作遙控器幾秒鐘後，參數會關閉，並保存於接收機中。

#### ■尺寸

對於 F.SP.，C.SP.，R.SP.和 S.W. 默認設定有下划線。

- F.SP.（前置揚聲器）
  - LARGE：一般情況下選擇此項。
  - SMALL：如果小型揚聲器用作前置揚聲器則選擇此項。
- C.SP.（中置揚聲器）
  - LARGE：一般情況下選擇此項。
  - SMALL：如果小型揚聲器用作中置揚聲器則選擇此項。
  - NO：如果不使用中置揚聲器則選擇此項。



- R.SP. (後置揚聲器)
  - LARGE：一般情況下選擇此項。確定位置和高度可以正確地實現“虛擬”聲場（第 48 頁）中的“數字影院環繞”模式。
  - SMALL：如果小型揚聲器用作後置揚聲器則選擇此項。確定位置和高度可以正確地實現“虛擬”聲場（第 48 頁）中的“數字影院環繞”模式。
  - NO：如果不使用後置揚聲器則選擇此項。
- S.W. (低音揚聲器)
  - YES：如果使用低音揚聲器則選擇此項。
  - NO：如果不使用低音揚聲器則選擇此項。

### ■視聽距離

您可以如下來改變每個揚聲器的距離。默認設定有下列線。

- F.D. 5m (前置揚聲器距離)
  - 前置揚聲器距離可以以 0.2m 遞增，在 1.0 到 15.0m 之間設定。
- C.D. 5m (中置揚聲器距離)
  - 中置揚聲器距離可以從前置揚聲器距離，以 0.2m 遞增，朝您的收聽位置靠近最多 1.6m。
- R.D. 3.4m (後置揚聲器距離)
  - 後置揚聲器距離可以從與前置揚聲器相同的距離處，以 0.2m 遞增，朝您的收聽位置靠近最多 4.6m。

### 注意

如果每個前置揚聲器或者後置揚聲器沒有放置在距離收聽位置相同的距離上，則要調整最近的揚聲器的距離。

### 確定後置揚聲器的位置和高度

如果您在“R.SP.”中選擇了“NO”以外的任何選項，則要確定後置揚聲器的位置和高度。下劃線部分為默認設定。

#### 位置圖解

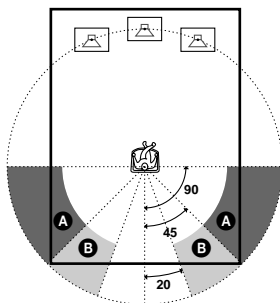

- R.P. BEHIND
  - 如果後置揚聲器被放置在 **B** 區域，則選擇此項。
- R.P. SIDE
  - 如果後置揚聲器被放置在 **A** 區域，則選擇此項。

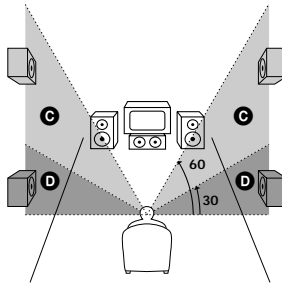

- R.H.LOW  
如果後置揚聲器被放置在 **D** 區域，則選擇此項。
- R.H.HIGH  
如果後置揚聲器被放置在 **C** 區域，則選擇此項。

當“R.SP.”選項設置成“NO”時，這些參數無效。

### 確定揚聲器間的平衡和音量等級

- 1 反覆按下 AMP MENU 鍵，直至前面板顯示幕內顯示 ♪ LEVEL。
- 2 使用 ↑/↓ 鍵選擇 T.TONE，然後使用 ←/→ 鍵將 T.TONE 設定為 ON。  
您可以依次聽到每個揚聲器發出的測試聲音。
- 3 坐在收聽位置，使用 ↑/↓ 鍵來選擇需調整的選項。
  - 在 ♪ LEVEL 中調整的選項
    - 前置揚聲器與後置揚聲器之間的平衡
    - 中置揚聲器與後置揚聲器，及低音揚聲器的音量等級
- 4 使用 ←/→ 鍵來調整音量等級，使每個揚聲器中發出的測試聲音音量聽起來一致。  
前面板顯示幕內將顯示所調整量的值。
- 5 重複步驟 3 和 4，調整 ♪ LEVEL 中的其它參數。  
如果幾秒鐘內沒有操作遙控器，顯示幕內的顯示值將消失，並被儲存到接收機中。
- 6 使用 ↑/↓ 鍵選擇 T.TONE，然後使用 ←/→ 鍵將 T.TONE 設定為 OFF。

### ■平衡調整

您可以按如下方法來調整每個揚聲器的平衡。默認設定有下划線。

- F. ....|..... (中間) (前置揚聲器)  
調整前左揚聲器和前右揚聲器之間的平衡（您可以從中間調整，向左或向右各有 6 級）。
- R. ....|..... (中間) (後置揚聲器)  
調整後左揚聲器和後右揚聲器之間的平衡（您可以從中間調整，向左或向右各有 6 級）。

## ■水平

您可以按如下方法來調整每個揚聲器的音量等級。默認設定有下列線。

- C.LEVEL 0 dB (中置揚聲器音量等級)  
調整中置揚聲器的音量等級 (可用範圍從 -10dB 到 +10dB, 調節步幅為 1dB)。
- R.LEVEL 0 dB (後置揚聲器音量等級)  
調整後置揚聲器的音量等級 (可用範圍從 -10dB 到 +10dB, 調節步幅為 1dB)。
- S.W.LEV. 0 dB (低音揚聲器音量等級)  
調整低音揚聲器的音量等級 (可用範圍從 -10dB 到 +10dB, 調節步幅為 1dB)。

## ■注意

- 當您選擇一個選項時, 聲音會停頓短暫時間。
- 根據其它揚聲器設置的不同, 低音揚聲器可能會輸出過大的聲音。

## 同時調整所有揚聲器的音量

使用 VOLUME 控制器。

## 其它的“AMP MENU”設置

您可以控制前面板顯示幕內的亮度, 清除預置電台和電台名, 並將揚聲器的參數恢復至默認狀態。反覆按下 AMP MENU 鍵, 直至顯示 ♪ CUSTOMIZE 的字樣。使用 ↑/↓ 鍵可選擇以下的選項。

## ■顯示幕調光器 (DIMMER)

可以用兩種方法改變前面板顯示幕的亮度。使用 ←/→ 調節設定或按 DIMMER 鍵。

## ■MEMO.CLR.

您可以清除預置電台或電台名稱, 並將揚聲器參數恢復至默認設定。

- MEMO.CLR.N (不) : 按 ENTER 鍵跳回到前一選單。
- MEMO.CLR.Y (是) : 如果按 ENTER 鍵, 會出現 “Really? N”。要清除記憶, 用 ←/→ 選擇 “Really? Y” 並按 ENTER 鍵。出現 “ALL CLEAR!”, 所有設定如預置電台和電台名稱將被清除, 且揚聲器參數將恢復至默認設定。

# 預設電台

您可以預置 20 個調頻電台和 10 個調幅電台。  
調諧電台前，須將音量關至最小。

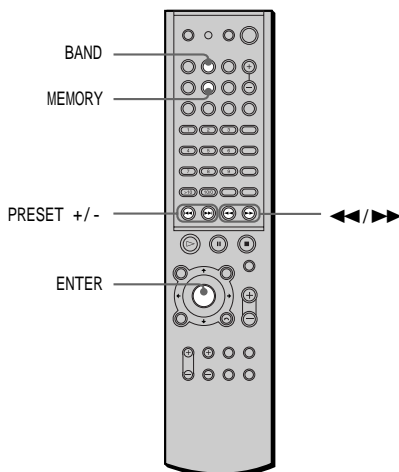

- 1 反覆按下 BAND 鍵，直到前面板顯示幕內出現所需的波段。  
每次按下 BAND 鍵時，波段會在 AM 和 FM 之間輪流轉換。
- 2 按住 ◀◀ 或者 ▶▶ 鍵，直到頻率顯示開始變化，然後鬆開鍵。  
當接收機調諧到一個電台時，掃描會停止。前面板顯示幕內顯示出“TUNED”和“ST”（對於立體聲節目）字樣。

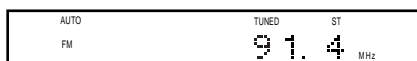

- 3 按下 MEMORY 鍵。  
前面板顯示幕內出現一個預置號。

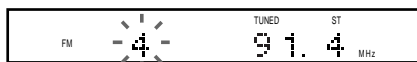

- 4 按下 PRESET + 或者 PRESET - 鍵來選擇所需的預置號。



- 5 按 ENTER 鍵。  
電台被存儲。

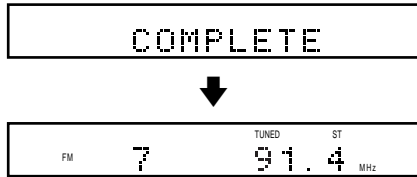

- 6 重複步驟 1 到 5 存儲其他的電台。

#### 調諧信號微弱的電台

在步驟 2 中反覆按 ◀◀ 鍵或 ▶▶ 鍵手動調到某一電台。

#### 改變預先設置的數字

再一次從 1 開始。

#### 改變 AM 調諧間隙

廠家通常將 AM 調頻間隙設置為 9KHZ (某些地區為 10KHZ)。

要改變 AM 調頻間隙，先調到任一個 AM 電台，然後按遙控器上的 |/⏻ 鍵關閉電源。在按住 鍵 (接收機上) 時，再重新打開電源。當您改變間隙時，先前設置的 AM 電台將會被抹去。

要重新設定間隙，重複同樣的過程。

# 播放光碟



不同的 DVD 和 VIDEO CD，它們的一些操作可能不同或有一定的限制。

參照隨影碟附帶的操作說明。

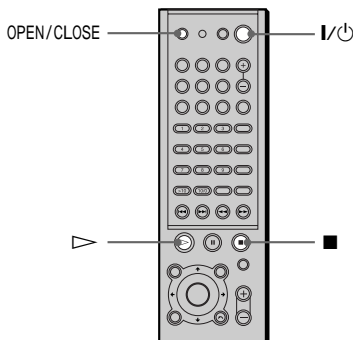
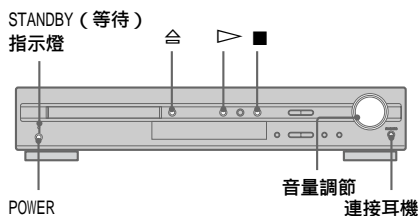

**1** 打開電視。

**2** 將電視機的輸入選擇切換至本接收機。

**3** 按下本接收機的 POWER 鍵。  
接收機進入等待模式，STANDBY 指示燈點亮為紅色。

**4** 按 鍵或者按遙控器上的 OPEN/CLOSE 鍵，把光碟放入光碟托架。

接收機自動開啟且 STANDBY 指示燈熄滅。

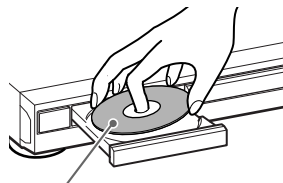

播放面朝下

**5** 按 鍵。  
光碟托架關閉，接收機開始播放（連續播放）。調節接收機音量。

## 第 5 步以後

根據不同的光碟電視屏幕上會顯示一個選單。您可以根據選單上的說明交互式播放影碟。DVD（第 32 頁），VIDEO CD（第 33 頁）。

## 打開接收機

按接收機上的 POWER 鍵。接收機進入等待模式且 STANDBY 指示燈點亮為紅色。按遙控器上的 I/O 鍵。接收機開啟且 STANDBY 指示燈熄滅。在等待模式中，按接收機上的 鍵或 鍵也可以打開接收機電源。

## 關閉接收機

按遙控器上的 I/O 鍵。接收機進入等待模式且 STANDBY 指示燈點亮為紅色。要完全關閉接收機，請按接收機上的 POWER 鍵。播放光碟時，請勿按 POWER 鍵關閉接收機。否則可能會取消選單設定。當要關閉接收機時，先按 鍵停止播放，然後按遙控器上的 I/O 鍵。

## 在等待模式中節電

按一下遙控器上的 **1/⏻** 鍵。

 當接收機處於等待模式時，接收機上的 STANDBY 指示燈處於點亮。

## 要取消等待模式

按一下遙控器上的 **1/⏻** 鍵。

### 補充操作

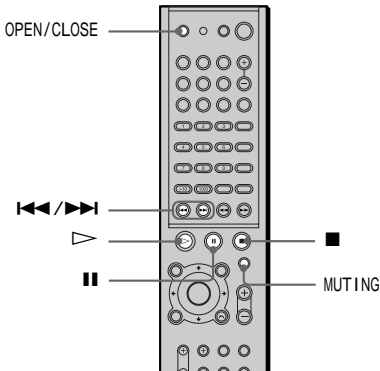

要	操作
停止	按 <b>■</b> 鍵。
暫停	按 <b>  </b> 鍵。
暫停後繼續播放	按 <b>  </b> 或 <b>▷</b> 鍵。
在連續播放模式中進至下一章軌跡或場面	按 <b>▶▶</b> 鍵。
在連續播放模式中進至上一章軌跡或場面	按 <b>◀◀</b> 鍵。
停止播放並取出影碟	按 OPEN/CLOSE。
靜音	按 MUTING 鍵。要取消靜音，再按一次 MUTING 鍵，或把音量放大。

### 注意

關閉光碟托架必須通過按 OPEN/CLOSE 鍵，不能用手推光碟托架。

## 從停止的地方恢復播放光碟（恢復播放）



當您 **■** 鍵停止播放時，接收機已記住您暫停的那一位置。接收機前顯示面板上顯示 “RESUME”。只要您不打開光碟托架，即使您按下 **1/⏻** 鍵接收機進入了等待狀態，恢復播放功能仍有效。

播放光碟

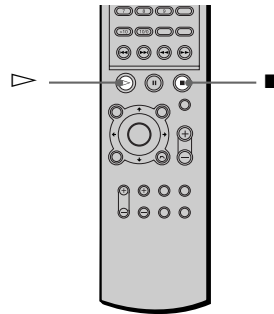

### 1 播放光碟時，按 **■** 鍵停止播放。

“RESUME” 顯示在前顯示面板上，因而您可以從您停止的地方重新播放影碟。

如果 “RESUME” 沒有顯示，則不能進行繼續播放。

### 2 按 **▷** 鍵。

接收機從步驟 1 中停止的地方開始播放。

 要從頭開始播放光碟，按兩次 **■** 鍵，然後按 **▷** 鍵。

## 注意

- 根據停止播放的位置不同，接收機可能不能精確地從停止點繼續播放。
- 當在下列情況下，停止播放的點將會很清楚：
  - 當您關閉接收機上的 POWER 鍵時。
  - 當您改變播放模式時。

## 使用 DVD 選單

### DVD

DVD 光碟被分為很長的幾個畫面或音樂特寫部分，這些稱作“標題”。播放含有多個標題的 DVD 光碟時，您可以使用 DVD TOP MENU 選擇所要的標題。

播放可以選擇字幕語言和聲音語言等項目的 DVD 光碟時，請使用 DVD MENU 選擇這些項目。

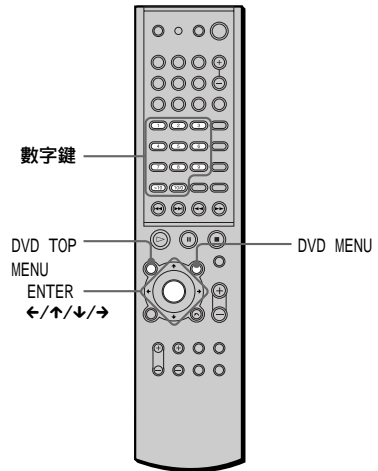

- 1** 按 DVD TOP MENU 或 DVD MENU 鍵。  
光碟選單顯示在電視屏幕上。  
不同的光碟其選單內容不一樣。
- 2** 按 ←/↑/↓/→ 鍵或數字鍵來選擇您要播放或改變的項目。
- 3** 按 ENTER 鍵。



# 用 PBC 功能播放 VIDEO CD 光碟 (PBC 播放)

VIDEO CD

運用 PBC (播放控制) 功能, 您可以享有簡單的交互操作、搜索功能和其他一些類似的操作。按照以下電視屏幕上的選單, PBC 播放功能允許您交互式播放 VIDEO CD。

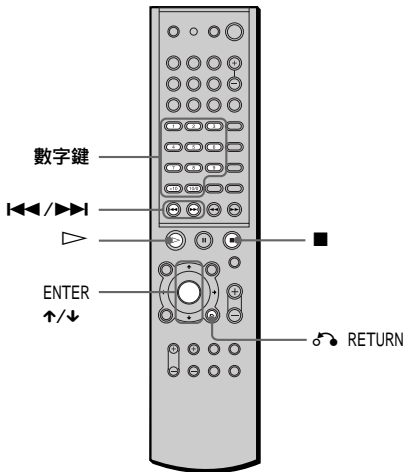

**1** 用 PBC 功能開始播放 VIDEO CD。  
屏幕上顯示供您選擇的選單。

**2** 按  $\uparrow/\downarrow$  鍵或者數字鍵來選擇所要的項目號。

**3** 按 ENTER 鍵。

**4** 按照選單中的說明進行交互式操作。

參照隨光碟一起附帶的說明, 因為 VIDEO CD 的操作過程可能各有不同。

回到選單

按  $\curvearrowright$  RETURN 鍵。

💡 要不用 PBC 功能播放, 當接收機停止時按  $\lll/\ggg$  鍵或者數字鍵來選擇一個軌跡, 然後按  $\triangleright$  鍵或者 ENTER 鍵。

電視屏幕上顯示“不以 PBC 方式播放”, 接收機開始連續播放。您不能播放靜止的畫面如選單。要返回 PBC 播放, 按兩次  $\blacksquare$  鍵, 然後按  $\triangleright$  鍵。

## 注意

在一些與光碟一起附帶的說明中, 步驟 3 中的“按 ENTER 鍵”可能顯示為“按 SELECT 鍵”, 這取決於不同的 VIDEO CD。在這種情況下按  $\triangleright$  鍵。

播放光碟

# 創建自己的程序 (編序播放)

DVD

VIDEO CD

SA-CD CD

您可以通過編一個程序來把光碟中的標題，章或軌跡排序，使得光碟中的內容按您想要的順序播放。最多可編 25 個標題，章和軌跡。

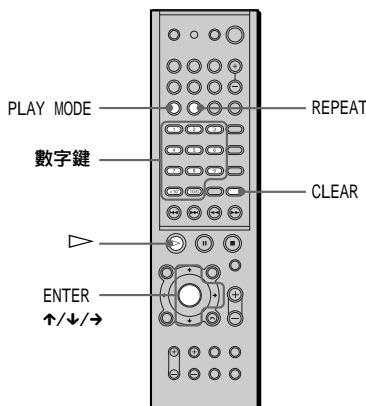

**1** 在停止模式時，反覆按 PLAY MODE 鍵，直到在接收機前顯示面板上出現“PROGRAM”。

編序顯示出現在電視屏幕上。

當您播放 VIDEO CD, Super Audio CD, 或者 CD 時，顯示“軌跡”。

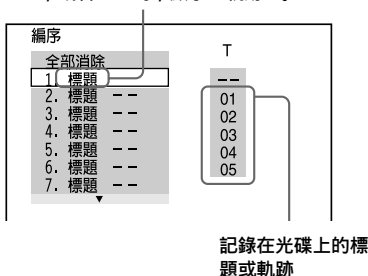

**2** 按 → 鍵。  
光標移動到某一標題或軌跡（這裡是“01”）。

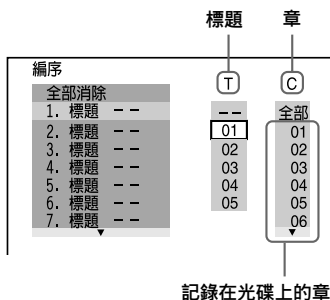

**3** 選擇您要編序的標題，章和軌跡。

■ 當播放 DVD 時

例如選擇 02 標題中的 03 章。

按 ↑/↓ 鍵或者數字鍵在“T”下選擇“02”，然後按 ENTER 鍵。

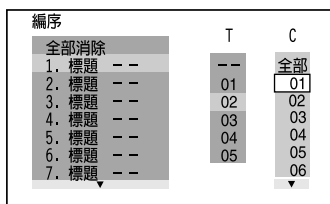

下一步是按 ↑/↓ 鍵或者數字鍵來選擇“C”下的“03”，然後按 ENTER 鍵。

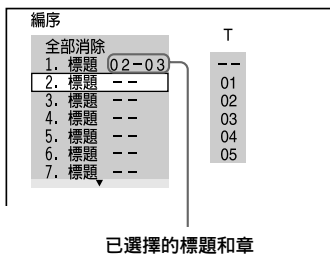

■ 播放 VIDEO CD, Super Audio CD, 或 CD 時

例如選擇軌跡“02”。

按  $\uparrow/\downarrow$  鍵或數字鍵選擇“T”下的“02”，然後按 ENTER 鍵。

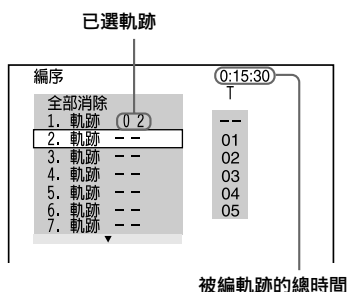

取消已編序順序

要取消所有標題，章和軌跡的編序順序，按  $\uparrow$  鍵，然後在步驟 2 中選擇“全部消除”。取消選擇的編序，則在步驟 2 中用  $\uparrow/\downarrow$  鍵選擇此編序，然後按 CLEAR，或者在步驟 3 中選擇“--”，然後按 ENTER 鍵。

💡 您可以重複播放被編序的標題，章或軌跡。按 REPEAT 鍵，或者在編序播放時，在控制選單顯示中將“重複”設定為開。

### 注意

播放的標題，章或軌跡的序號與記錄在光碟上的序號是一樣的。

## 4 要編序其他的標題，章或軌跡，重複步驟 2 至 3。

已編序的標題，章和軌跡將按被選擇的順序播放。

## 5 按 $\triangleright$ 鍵開始編序播放。

編序播放開始。

當編序播放結束時，您可以按  $\triangleright$  鍵再次開始此編序的播放。

要返回正常播放

在播放時按 CLEAR 鍵。

要關閉編序選單

在停止模式下，按 PLAY MODE 來關閉編序選單。

要改變編序

1 在步驟 2 中，用  $\uparrow/\downarrow$  鍵或數字鍵選擇您所要改變的標題，章或軌跡，然後按  $\rightarrow$  鍵。

2 依據步驟 3 進行新的編序。

## 隨機播放 (隨機播放)

DVD

VIDEO CD

SA-CD

您可以讓接收機“隨機”標題、章或軌跡並以隨著順序播放。每次“隨機”會產生不同的播放順序。

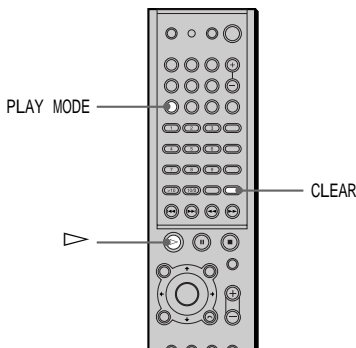

**1** 在停止模式，連續按 PLAY MODE 鍵直到接收機前顯示面板上顯示“SHUFFLE”。

**2** 按 ▷ 鍵。

### 要返回正常播放

在停止模式下，按兩次 PLAY MODE 鍵或者是在播放時按 CLEAR 鍵回到正常播放。

#### 注意

- 在下列情況下隨機播放將被取消：
  - 打開或關閉光碟托架。
  - 關閉電源。
  - 切換功能。
- 有些 DVD 不能進行隨機播放。

## 反覆播放 (重複播放)

DVD

VIDEO CD

SA-CD

您可播放光碟上的所有標題/軌跡或僅僅是某一標題/章/軌跡。

在隨機播放或編序播放模式中，接收機分別按隨機順序或編序順序重複播放標題或軌跡。

您不能在用 PBC 功能播放 VIDEO CD 時進行重複播放。(第 33 頁)

有些 DVD 機可能不能進行重複播放。

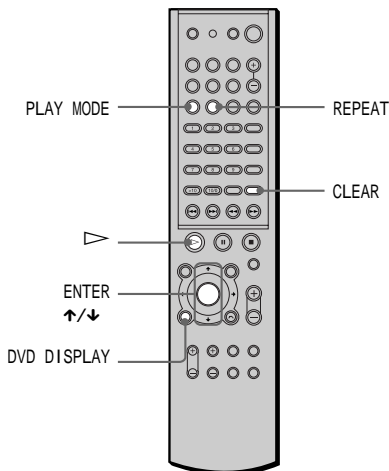

**1** 按 DVD DISPLAY 鍵。  
出現控制選單。

**2** 按 ↑/↓ 鍵選擇  (重複) 然後按 ENTER 鍵。

如果您不選擇“關”，“REPEAT”指示燈將點亮為綠色。

### 3 選擇重複播放設定。

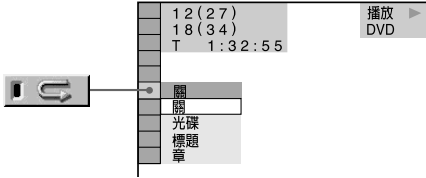

當播放 DVD 且編序播放設定為關時

- 關：不反覆播放。
- 光碟：重複播放所有標題。
- 標題：重複播放當前光碟上的標題。
- 章：重複播放當前章。

當播放 VIDEO CD/Super Audio CD/CD 且編序播放設定為關時

- 關：不反覆播放。
- 光碟：重複播放光碟上的所有軌跡。
- 軌跡：重複播放當前軌跡。

當編序播放設定為開時

- 關：不反覆播放。
- 開：重複編序播放。

取消重複播放

按 CLEAR 鍵。

 您可以在停止模式下設定重複播放  
選擇“重複”項，按 ▷ 鍵。接收機開始重複播放。

 快速顯示“重複”狀態  
按遙控器的 REPEAT 鍵。

#### 注意

當在下列情況下重複播放被取消：

- 關閉電源。
- 切換功能。

# 搜尋光碟上的特定位置

(掃描, 慢速播放)



您可以通過監視畫面或慢速播放來快速查找光碟上的某一特定位置。

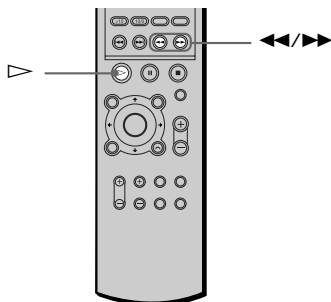

### 注意

有些 DVD/VIDEO CD 機不能進行上面所描述的操作。

## 通過快進或快退來快速查找某一點 (掃描)

播放光碟時按 ◀◀ 或 ▶▶ 鍵。當發現您所要找的那一點時, 按 ▷ 鍵回到正常的播放速度。

掃描時每按一次 ◀◀ 或 ▶▶ 鍵, 播放速度將改變。可以獲得三種速度。每按一次其指示改變如下:

播放方向



相反方向

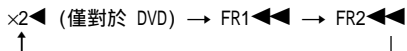

×2▶/×2◀ 的播放速度約為正常速度的 2 倍。FF2▶▶/FR2◀◀ 的播放速度快於 FF1▶▶/FR1◀◀。

## 逐幀觀看畫面 (慢放)



您只能在 DVD 或 VIDEO CD 機上使用這一功能。當本接收機處於暫停狀態時, 按 ◀◀ 或 ▶▶ 鍵。按 ▷ 鍵回到正常播放速度。

每次在慢放時按 ◀◀ 或 ▶▶ 鍵, 播放速度發生改變。可以獲得兩種速度。每按一次指示改變如下:

播放方向

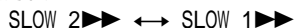

相反方向 (只限 DVD)

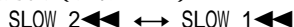

SLOW 2▶▶/SLOW 2◀◀ 的播放速度慢於 SLOW 1▶▶/SLOW 1◀◀。

# 搜尋標題/章/軌跡/索引/ 場面

DVD

VIDEO CD

SA-CD CD

您可以通過標題或章來搜索一張 DVD 光碟，同樣您也可以通過軌跡、索引或畫面來搜索一張 VIDEO CD/CD 光碟。因為在光碟上每一標題和軌跡都被設為特定的編號，所以您需輸入它的編號就可選擇您想要的那一個。或者您可以通過時間編碼來選擇某一畫面。（時間搜索）

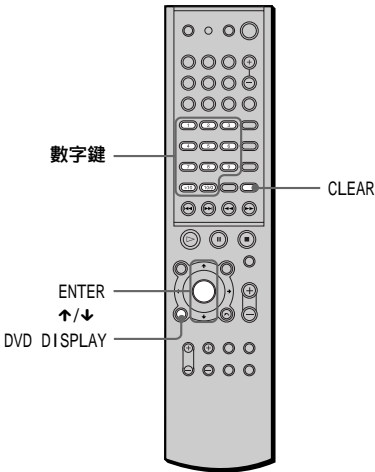

**1** 按 DVD DISPLAY 鍵。  
出現控制選單。

**2** 按 ↑/↓ 鍵選擇搜索方法。

■ 播放 DVD 時

(標題)， (章)，或 (時間/文字)  
選擇時間/文字進行時間搜索。

■ 播放 VIDEO CD 時

(軌跡) 或 (索引)

■ 用 PBC 播放功能播放 VIDEO CD 時

(場面)

■ 播放 Super Audio CD/CD 時

(軌跡) 或 (索引)

例如：當您選擇 (章) 時，則選擇 “\*\*(\*\*)” (\*\* 對應某一數字)。

括弧里的數字表示所有的標題、章、軌跡、索引或畫面的總數。

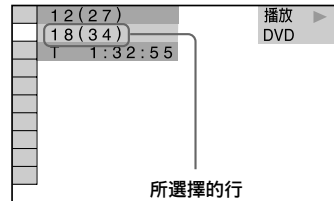

**3** 按 ENTER 鍵。

“\*\*(\*\*)” 變為 “(\*\*)”。

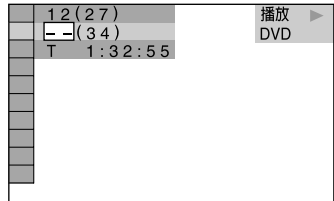

**4** 按 ↑/↓ 鍵或者數字鍵來選擇您要搜索的標題、章、軌跡、索引或畫面的數字編碼。

如果您操作有誤

按 CLEAR 鍵取消您選的數字，然後選擇其他的數字。

---

## 5 按 ENTER 鍵。

接收機從您選擇的那一數字開始播放。

---

### 關閉控制選單

連續按 DVD DISPLAY 鍵直到控制選單被關閉。

### 用時間編碼來搜索某一畫面（時間搜索） （只限 DVD）

1 在步驟 2 中選擇 （時間/文字）。

選擇了“T \*\*: \*\*: \*\*”。（當前標題的播放時間）

2 按 ENTER 鍵。

“T \*\*: \*\*: \*\*”變為“T --:--:--”。

3 用數字鍵輸入時間編碼，然後按 ENTER 鍵。

例如，要找開始後 2 小時 10 分 20 秒的畫面，只需輸入“2:10:20”。

### 注意

所顯示的某一標題、章或軌跡的編碼與記錄在光碟上的是一致的。



# 瀏覽前面板顯示幕上的 播放時間和剩餘時間

DVD

VIDEO  
CD

SA-CD  
CD

用前面板顯示幕可以顯示有關影碟的資訊如：剩餘時間、DVD 影碟的總標題數，或 Super Audio CD、CD 或 VIDEO CD 的軌跡數（第 10 頁）。

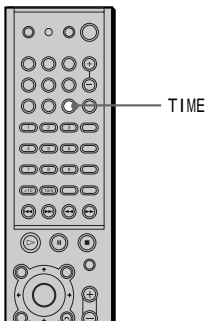

## 按 TIME 鍵。

當播放影碟時，每按一次 TIME 鍵顯示的內容就會變化，這種變化在下面的圖形中說明。

## 播放 DVD 時

當前標題的播放時間和號碼

TITLE	CHAPTER	H	M	S
1	2	10	32	4

當前標題的剩餘時間

TITLE	CHAPTER	H	M	S
1	2	-11	53	6

當前章的播放時間和號碼

CHAPTER	H	M	S
2	02	23	0

當前章的剩餘時間

CHAPTER	H	M	S
2	-01	32	0

文字

SONY HITS/

播放 VIDEO CD（無 PBC 功能），Super Audio CD 或 CD 時

播放時間和當前軌跡號碼

TRACK	INDEX	M	S
2	1	22	5

當前軌跡的剩餘時間

TRACK	INDEX	M	S
2	1	-15	0

光碟的播放時間

M	S
32	12

光碟的剩餘時間

M	S
-20	18

文字

SONY HITS/

💡 當播放沒有 PBC 功能的 VIDEO CD 光碟時，顯示場面號和播放時間。

💡 當前的章、標題、軌跡、場面或光碟的播放時間和剩餘時間也將在電視機屏幕上出現。參看下一部分的“查看播放時間和剩餘時間”。這是有關怎樣讀懂這些資訊的說明。

### 注意

- 當播放 Super Audio CD 時，索引指示標記不出現在前面板顯示幕上。
- 這些影碟資訊的出現與否，與你正在播放的影碟類型和播放模式有關。

## 查看播放時間和剩餘時間

DVD

VIDEO  
CD

SA-CD  
CD

您能查看光碟當前標題、章或軌跡的播放時間剩餘時間，以及總播放時間或剩餘時間。您也能查看記錄在影碟上的 DVD/CD/Super Audio CD 文字資訊。

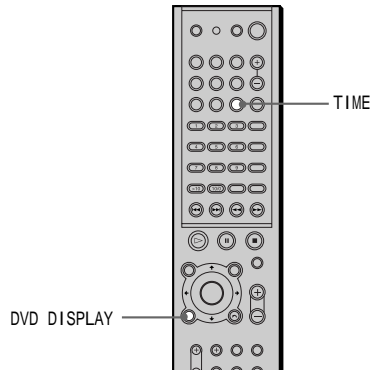

**1** 在播放過程中，按 DVD DISPLAY 鍵。

出現控制選單。

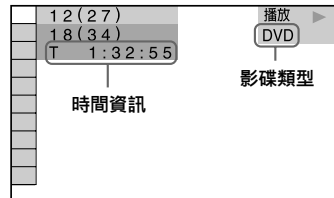

## 2 反覆地按 TIME 鍵改變時間資訊。 您能改變的顯示和時間類型與您正在播放的光碟有關。

### ■當播放 DVD 光碟時

- T\*\* : \*\* : \*\*  
當前標題的播放時間
- T\_ \*\* : \*\* : \*\*  
當前標題的剩餘時間
- C\*\* : \*\* : \*\*  
當前章的播放時間
- C\_ \*\* : \*\* : \*\*  
當前章的剩餘時間

### ■當播放 VIDEO CD (有 PBC 功能) 光碟時

- \*\* : \*\*  
當前場面的播放時間

### ■當播放 VIDEO CD (無 PBC 功能) 或 Super Audio CD 或 CD 光碟時

- T\*\* : \*\*  
當前軌跡的播放時間
- T\_ \*\* : \*\*  
當前軌跡的剩餘時間
- D\*\* : \*\*  
當前光碟的播放時間
- D\_ \*\* : \*\*  
當前光碟的剩餘時間

### 關閉控制選單

反覆地按 DVD DISPLAY 鍵，直到控制選單關閉。

### 查看 DVD/CD/Super Audio CD 的文字

在步驟 2 中反覆地按 TIME 鍵顯示記錄在 DVD/CD/Super Audio CD 上的文字。僅當文字被記錄在光碟上時，DVD/CD/Super Audio CD 的文字才出現。您不能改變此文字。

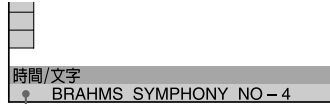

DVD/CD/Super Audio CD 文字

💡 如果 DVD/CD/Super Audio CD 文字在一行內顯示不下，可在前顯示幕上滾動觀看整個文字。

💡 按下 TIME 鍵可選擇時間和文字。

### 注意

- 僅在字母表里列出的字母才能顯示。
- 本接收機只能顯示一個級 DVD/CD/Super Audio CD 文字。如影碟名稱或標題。
- 在播放 Super Audio CD 時，本接收機只能顯示有限的字符。對於不同光碟，也可能所有文字字符均無法顯示。

## 改變聲音

DVD

VIDEO CD

SA-CD

如果 DVD 是以多語言錄製的，播放 DVD 時，可選擇您需要的語言。

如果 DVD 是以多音頻格式錄製的（PCM，杜比數碼，MPEG 音頻或 DTS），當播放 DVD 時可選擇您需要的格式。

對帶有立體聲的 CD 或 VIDEO CD 的碟片，您可從右側或左側聲道中選擇聲音，並能通過左右揚聲器聽到您選擇的聲道發出的聲音。（這種情況下，聲音沒有立體聲效果）。例如，當您播放的光碟含有一首歌，這首歌是在右聲道發音，左聲道有樂聲，此時您可選擇左聲道，並只能從兩個揚聲器聽到樂聲。

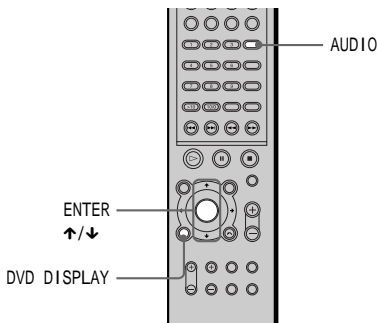

### 1 在播放過程中按下 DVD DISPLAY 鍵。

顯示控制選單。

### 2 按下 ↑/↓ 鍵選擇 （聲音語言），然後按 ENTER 鍵。聲音語言選項出現。

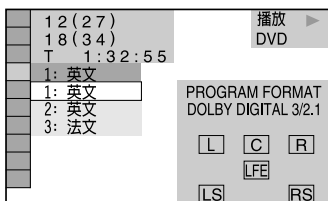

### 3 按 ↑/↓ 鍵選擇所需的聲音語言信號。

#### ■當播放 DVD 時

語言改變選項與播放的 DVD 光碟有關。

4 位數字顯示代表的是語言代碼。第 77 頁的語言代碼列表可以查出各語言代碼。當同種語言顯示兩次或兩次以上時，則此 DVD 是以多種音頻格式錄製的。

#### ■當播放 VIDEO CD 或 CD 時

下劃線部分為默認設定。

- STEREO：標準立體聲
- 1/L：左聲道聲音（單聲道）
- 2/R：右聲道聲音（單聲道）

#### ■當播放 Super Audio CD 時

在停止模式下，設定選項的變化與 Super Audio CD 碟片有關。

- MULTI：碟片有多聲道播放區。
- 2 CH：碟片有 2 個聲道播放區。
- CD：把光碟作為常規 CD 播放時。

#### **注意**

在 Super Audio CD 播放中，並不是所有碟片都能提供上述三種選擇。這與播放的 Super Audio CD 碟片的層結構有關

### 4 按 ENTER 鍵。

#### 關閉控制選單

反覆按 DVD DISPLAY 鍵直到控制選單關閉。

 按 AUDIO 鍵直接選擇“聲音語言”，每按一次此鍵，項目將改變。

#### **注意**

您不能改變非多音頻格式碟片的聲音。

## 顯示碟片的音頻資訊 **DVD**

當您選擇“聲音語言”項時，被播放的聲道就會顯示在屏幕上。例如，在杜比數碼格式下，從單聲道到 5.1 聲道信號的多種信號被錄製到 DVD 光碟上。被錄製聲道的數目與播放的 DVD 光碟有關。

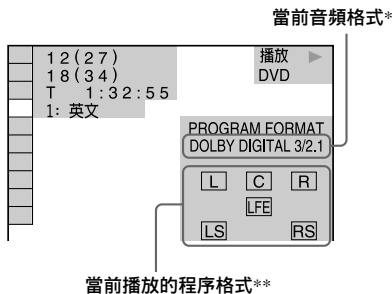

\* “PCM”，“MPEG”，“DTS”或“DOLBY DIGITAL”音頻格式被顯示出來。對“DOLBY DIGITAL”而言，播放軌跡中的聲道數字化顯示如下：

杜比數碼 5.1 聲道：



\*\* 程序格式化顯示選單中的字母表示下列聲音部分：

- L：前置（左）
- R：前置（右）
- C：中置
- LS：後置（左）
- RS：後置（右）
- S：後置（單聲道）：經杜比環繞處理的信號和杜比數碼信號的後置部分。
- LFE：LFE（低頻效果）

顯示例舉如下：

- PCM（立體聲）

PROGRAM FORMAT  
PCM 48kHz 24bit

- 杜比環繞

PROGRAM FORMAT  
DOLBY DIGITAL 2/0  
DOLBY SURROUND  
L C R  
S

- 杜比數碼 5.1 聲道  
當輸出一個低頻信號部分時，“LFE”有實線框起。當未輸出低頻信號部分時，“LFE”以虛線框起。

PROGRAM FORMAT  
DOLBY DIGITAL 3/2.1  
L C R  
LFE  
LS RS

- DTS  
不管“LFE”信號分量是否輸出，“LFE”始終以實線框起。

PROGRAM FORMAT  
DTS 3/2.1  
L C R  
LFE  
LS RS

### 注意

- 當信號包括後置信號部分，如 LS、RS 或 S 時，環繞效果被增強（第 46 頁）。
- 如果播放 MPEG 音頻聲音軌跡，本接收機輸出 PCM（立體聲）信號。

## 自動解碼音頻輸入信號

(自動格式解碼)



自動格式解碼功能自動檢測輸入音頻信號的類型（杜比數碼，DTS，或標準 2 聲道立體聲），並根據需要進行正確的解碼。該模式僅再現錄製 / 編碼時的聲音，不增加任何效果（如混響）。

但是，如果沒有低頻率信號（杜比數碼 LFE 等），它將產生一個低頻率信號輸出至低音揚聲器。

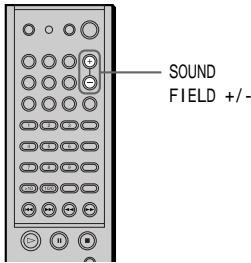

反覆按 SOUND FIELD +/- 鍵直至  
“A.F.D. (AUTO FORMAT DECODE)”  
顯示在前面板顯示幕上。

自動格式解碼功能被開啟。

## 欣賞環繞聲



您可以簡單地選擇接收機中的一個預編序聲場來欣賞環繞聲。它們可以將電影院和音樂廳動人且強有力的聲音帶入您的家中。

要選擇聲場，反覆按 SOUND FIELD +/- 鍵直至您想要的聲場出現在前面板顯示幕上。

聲場	顯示
普通環繞	N. SURROUND
電影演播室 EX A	C.S.EX.A*
電影演播室 EX B	C.S.EX.B*
電影演播室 EX C	C.S.EX.C*
虛擬多維空間	V. MULTI D.
虛擬半多維空間	V. S.M.D.
小型音樂廳	SMALL HALL
大型音樂廳	LARGE HALL
爵士樂俱樂部	JAZZ CLUB
現場原創	LIVE HOUSE
遊戲	GAME

\* 使用 DCS 技術

### 關於 DCS (數字影院音響)

與 Sony Picture Entertainment 合作，Sony 測量出他們演播室的聲音環境，並將測量數據與 Sony 公司自己的 DSP (數字信號處理器) 技術相結合，開發出“數字影院音響”技術。“數字影院音響”在家庭影院中根據電影導演的喜好模仿理想中的電影院聲音環境。

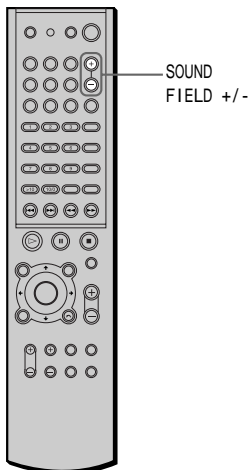

## 以電影演播室 EX 欣賞電影

電影演播室 EX 是一種欣賞杜比數碼 DVD 等使用多聲道格式編碼的電影軟體的理想模式。該模式再現 Sony Picture Entertainment 演播室的聲音特性。

反覆按 SOUND FIELD +/- 鍵直至“C.S.EX A (或 B, C)”顯示在前面板顯示幕上。

### C.S.EX A (電影演播室 EX A)

再現 Sony Picture Entertainment “Cary Grant Theater” 電影製作演播室的聲音特性。這是一種標準模式，適合於觀看大多數類型的電影。

### C.S.EX B (電影演播室 EX B)

再現 Sony Picture Entertainment “Kim Novak Theater” 電影製作演播室的聲音特性。這是觀看科幻片或動作片等包含各種聲音效果電影的理想模式。

### C.S.EX C (電影演播室 EX C)

再現 Sony Picture Entertainment 音樂配音室的聲音特性。這是觀看電影配樂以音樂為主的音樂電影或古典電影的理想模式。

### 關於電影演播室 EX

電影演播室 EX 包含一下三個要素。

- 虛擬多維空間  
從一對實際後置揚聲器創造出 5 對環繞視聽者的虛擬揚聲器。
- 屏幕深度匹配  
在電影院中，聲音似乎是從反射在電影屏幕上的畫面中傳出來。該要素通過將前置揚聲器的聲音“移動至”屏幕內，在您的視聽室中創造出同樣的感覺。
- 電影演播室混響  
再現電影院特有的混響。  
電影演播室 EX 是同時執行這些要素的組合模式。

### 注意

- 虛擬揚聲器產生的效果可能會增加播放信號中的噪音。
- 聆聽使用虛擬揚聲器的聲場時，您將無法聽到任何直接來自後置揚聲器的聲音。

## 選擇其他聲場

反覆按 SOUND FIELD +/- 鍵直至您想要的聲場顯示在前面板顯示幕上。

當前聲場顯示在前面板顯示幕上。

## N. SURROUND (普通環繞)

根據錄製方法播放包含多聲道環繞音頻信號的軟體。用杜比 Pro Logic 解碼帶 2 聲道音頻信號的軟體以創造環繞效果。

## V. MULTI D.\*

### (虛擬多維空間)

用 3D 聲音成像技術，從一對實際的後置揚聲器產生一個高於視聽者位置的虛擬後置揚聲器陣列。這種模式能以約 30° 角增加圍繞收聽者產生 5 對虛擬揚聲器。

側

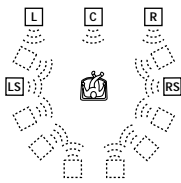

後

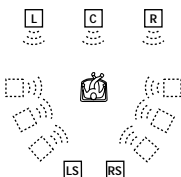

## V.S.M.D.\*

### (虛擬半多維空間)

不用真正的後置揚聲器而用 3D 聲音成像技術，從前置揚聲器的聲音中創建虛擬後置揚聲器。這種模式能以約 30° 角增加圍繞收聽者產生 5 對虛擬揚聲器。

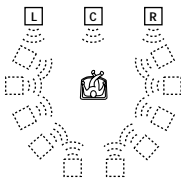

## SMALL HALL (小型音樂廳)

再現矩形小型音樂廳的原聲。

## LARGE HALL (大型音樂廳)

再現矩形大型音樂廳的原聲。

是輕柔原聲的理想選擇。

## JAZZ CLUB (爵士樂俱樂部)

再現爵士樂俱樂部的原聲。

## LIVE HOUSE (現場原創)

再現容納約 300 人的現場音樂廳原聲。

## GAME (遊戲)

從視頻遊戲軟體中獲得最大音頻壓縮。

## HEADPHONE THEATER (耳機劇院)

當您將耳機連接至接收機的 PHONES 插孔時，HEADPHONE THEATER 模式讓您通過一對耳機如身臨其境地體驗劇院效果。用杜比數碼和 DTS 等 5.1 聲道信號音源能使這種模式的效果更佳。選取任何聲場選項 (除 AUTO FORMAT DECODE 或 2 CH STEREO 以外) 都能使用此模式。

\* “虛擬”聲場：採用虛擬揚聲器的聲場。



## 要關閉環繞聲效果

反覆按 SOUND FIELD +/- 鍵直至 “A.F.D.” 或 “2CH STEREO” 顯示在前面板顯示幕上。

 接收機為每個功能模式記憶最後選定的聲場（聲場鏈接）

任何時候選擇 DVD 或 TUNER 等功能時，最後用於該功能的聲場再次被自動應用。例如，如果您用 SMALL HALL 作聲場來聆聽 DVD，當改變為其他功能，然後又返回 DVD 時，將再次應用 SMALL HALL。對於調諧器，各預設電台的聲場被分別記憶。

 查看包裝就可以識別節目軟體的編碼格式

- 杜比數碼光碟標有  標記。
- 杜比環繞編碼節目標有  標記。
- DTS 數碼環繞光碟標有 DTS 標記。

### 注意

當輸入採樣頻率為 96kHz 的聲音信號時，該聲音信號自動以立體聲形式輸出，且聲場關閉。

## 可調節參數

	FRONT BAL.	REAR BAL.	REAR LEVEL	CENTER LEVEL	SUB WOOFER LEVEL
C.S.EX A	●	●	●	●	●
C.S.EX B	●	●	●	●	●
C.S.EX C	●	●	●	●	●
N. SURROUND	●	●	●	●	●
V.MULTI D.	●	●	●	●	●
V.S.M.D.	●			●	●
SMALL HALL	●	●	●	●	●
LARGE HALL	●	●	●	●	●
JAZZ CLUB	●	●	●	●	●
LIVE HOUSE	●	●	●	●	●
GAME	●	●	●	●	●
HEADPHONE THEATER	●				

### 注意

根據光碟而定，上表所述的音頻信號可能無法輸出。詳細資訊，請參閱光碟的使用說明書。

## 僅使用前置揚聲器

(2 聲道立體聲)

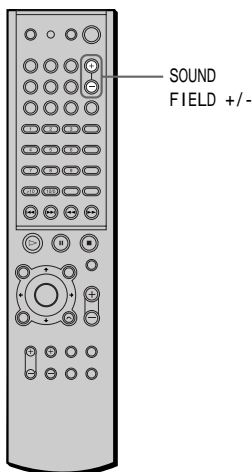

反覆按 SOUND FIELD +/- 鍵直至“2CH STEREO”顯示在前面板顯示幕上。

該模式僅從前置左和右揚聲器輸出聲音。標準 2 聲道（立體聲）音源完全通過此聲場處理。多聲道環繞格式被合併為 2 聲道。

### 注意

選擇了“2CH STEREO”時，低音揚聲器中無聲音輸出。要用前置左和右揚聲器以及低音揚聲器收聽 2 聲道（立體聲）音源，請反覆按 SOUND FIELD +/- 鍵選擇“A.F.D.”。

## 調節音量等級參數



音量等級選單包含可用以調整平衡和每個揚聲器的揚聲器音量的參數（第 26 頁）。

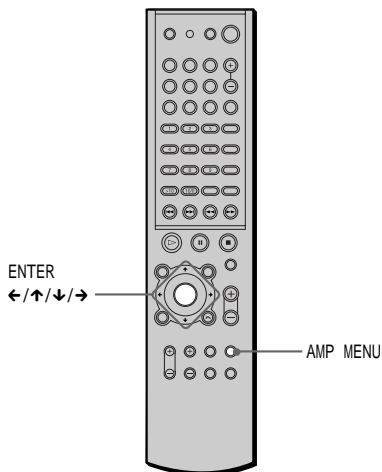

- 1 開始播放用多聲道環繞聲編碼的節目源。
- 2 反覆按 AMP MENU 鍵。  
♪ LEVEL 顯示在前面板顯示幕內。
- 3 坐在收聽位置用 ↑/↓ 鍵選擇要調整的項目。
- 4 用 ←/→ 鍵調整音量等級。  
調整值將出現在前面板顯示幕上。若幾秒鐘內不操作遙控器，這個值將關閉並儲存在接收機中。

## 變換角度

如果 DVD 上對每一場面錄有各種角度（多角度），前面板顯示幕上將出現“ANGLE”選單。這表明您能改變視角。

例如，當您播放正在行進的火車場面時，您能從火車的前面，火車的左窗口或右窗口顯示景色，而無需火車停下。

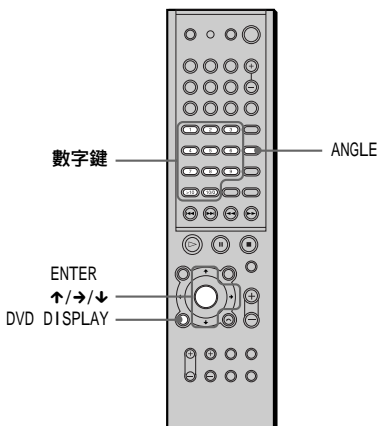

**3** 按 **→** 鍵或 **ENTER** 鍵。  
角度變化為“-”。

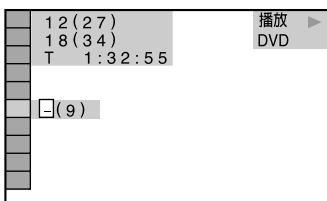

**4** 用數字鍵或 **↑/↓** 鍵選擇角度，然後按 **ENTER** 鍵。  
角度轉變為所選擇的角度。

### 關閉控制選單

反覆地按 **DVD DISPLAY** 鍵，直到控制選單關閉。

 可以按 **ANGLE** 鍵直接選擇角度。每按一次這個按扭，角度變化一次。

### 注意

有的 DVD，即使光碟上錄有多角度，但也可能無法改變角度。

**1** 在播放過程中按 **DVD DISPLAY** 鍵。  
出現控制選單。

**2** 按 **↑/↓** 鍵選擇 （角度）。  
出現角度的值。  
括號中的數值為總角度。

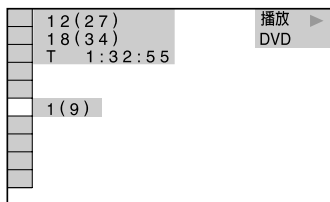

## 顯示字幕

如果光碟錄有字幕，在播放時可以打開或關閉字幕。如果光碟錄有不同語言的字幕，在播放時可以切換字幕語言，或您可以隨時打開或關閉字幕。例如，選擇您需練習的語言，打開字幕以便更好的理解。

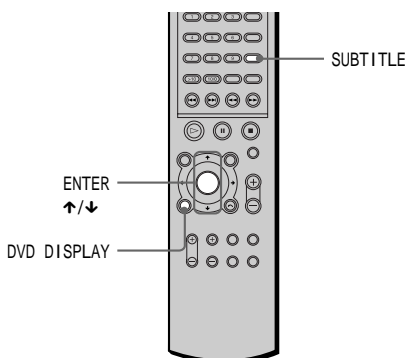

**1** 播放時按下 DVD DISPLAY 鍵。  
出現控制選單。

**2** 按 ↑/↓ 選擇  (字幕)，然後按下 ENTER 鍵。  
出現字幕選項。

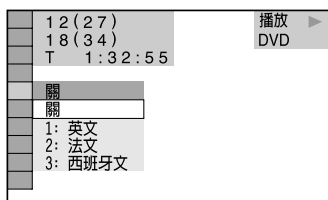

**3** 按 ↑/↓ 鍵選擇語言。  
不同的 DVD 光碟有不同的選擇語言。

顯示的 4 位數表示語言的代碼。  
參照第 77 頁的語言代碼列表，觀看各代碼所表示的語言。

**4** 按 ENTER 鍵。

### 取消字幕設置操作

在第 3 步中選擇“關”。

### 關閉控制選單

反覆按 DVD DISPLAY 鍵直到控制選單關閉。

 可以直接按 SUBTITLE 鍵選擇字幕。每按一次，選項就改變一次。

### 注意

對於不同的 DVD，即使錄有多種語言字幕，也可能無法改變字幕語言。

# 查看播放資訊 (先進功能)

## DVD

您能查看資訊如：正在播放的比特速率或光碟層。當播放光碟時，播放畫面近似比特速率總是以 Mbps (兆比特每秒) 顯示，音頻以 kbps (千比特每秒) 顯示。

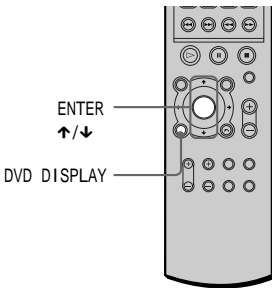

**1** 在播放過程中，按 DVD DISPLAY 鍵。

顯示控制選單。

**2** 按 ↑/↓ 鍵選擇  (先進功能)，然後按 ENTER 鍵。

出現先進功能選項。

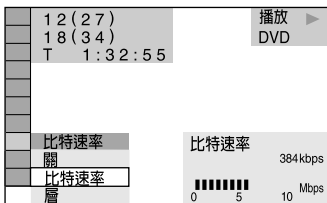

**3** 按 ↑/↓ 鍵選擇項目。

每一項請查閱參考“每項顯示”選單。

- 比特速率：顯示比特速率。
- 層：顯示層和拾音點。

**4** 按 ENTER 鍵。

要關閉“高級選項”窗口

在步驟 3 中選擇“關”。

要關閉控制選單

反覆按 DVD DISPLAY 鍵直到控制選單關閉。

## 每個選項顯示

通過反覆按 DVD DISPLAY 鍵，您能顯示“比特速率”或“層”。這兩項都在“先進功能”中選擇。

比特速率

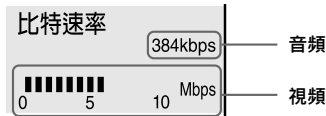

當正在播放 MPEG 音頻聲音軌跡時

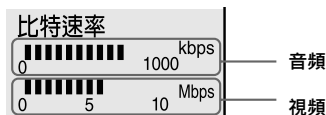

比特速率是指光碟上視頻/音頻每秒數據量，比特速率越高，數據量越大。當比特速率水平很高時，說明有大量的數據量，然而這並不意味著能得到更高品質的圖像或聲音。

層



表示光碟正在播放的近似點。

如果是一個雙層 DVD 光碟，接收機顯示哪一層正在被讀取 (“Layer 0” 或 “Layer 1”)。

有關層的詳細說明參看第 75 頁 (DVD)。

## 鎖住碟片（用戶鎖定，視聽者年齡控制）

您可以設定兩種光碟播放限制。

- 用戶鎖定  
設定播放限制使接收機不播放不合適的光碟。
- 視聽者年齡控制  
根據預先確定的等級，如使用者的年齡，可限制播放某些 DVD。  
視聽者年齡控制和用戶鎖定使用相同的密碼。

### 用戶鎖定



可最多為 50 張碟片設置相同的用戶鎖定密碼。但當您為第 51 張設置時，第 1 張光碟的播放限制就會被取消。

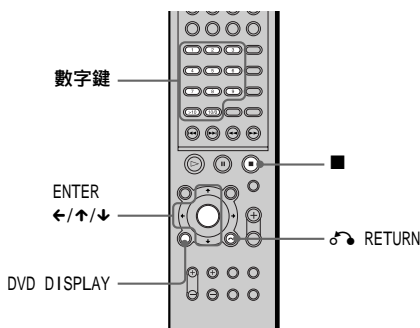

- 1 裝入想鎖定的光碟。  
若光碟正在播放，按 **■** 鍵停止播放。
- 2 在停止模式下，按 DVD DISPLAY 鍵。  
出現控制選單如下。

- 3 按 **↑/↓** 鍵選擇 （用戶鎖定），再按 ENTER 鍵  
“用戶鎖定”被選擇。

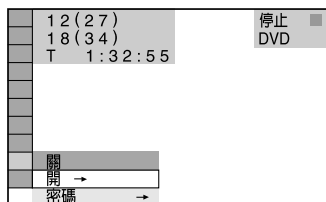

- 4 按 **↑/↓** 選擇“開”鍵，再按 ENTER 鍵。

- 如果還未輸入密碼  
出現用於注冊新密碼的顯示畫面。

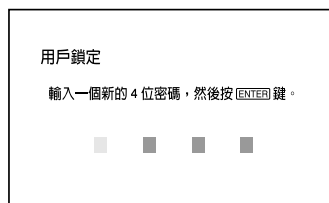

用數字鍵輸入 4 位密碼，然後按 ENTER 鍵，然後會出現要求確認密碼的顯示畫面。

- 當已註冊密碼  
出現要求輸入密碼的畫面顯示。

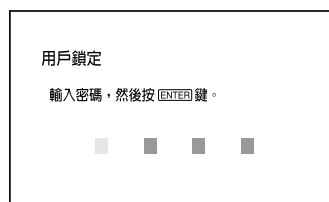

- 5 使用數字鍵輸入或重新輸入 4 位密碼，然後按 ENTER 鍵。

出現“用戶鎖定功能已設定”後，屏幕重新回到控制選單。

如果輸入密碼有誤

在按 ENTER 鍵之前按 ← 鍵，並輸入正確數字。

如果操作有誤

按 ↶ RETURN 鍵，然後再從第 3 步重新開始。

要關閉控制選單

按 ↶ RETURN 鍵，再反覆按 DVD DISPLAY 鍵直到關閉控制選單。

要關閉用戶鎖定功能

- 1 在步驟 4 中，選擇“關”，然後按下 ENTER 鍵。

- 2 用數字鍵輸入 4 位數密碼，然後按 ENTER 鍵。

要改變密碼

- 1 在步驟 4 中，按 ↑/↓ 鍵選擇到“密碼”，再按 ENTER 鍵，出現要求輸入密碼畫面。
- 2 用數字鍵輸入 4 位數密碼，然後按 ENTER 鍵。
- 3 用數字鍵輸入新的 4 位數密碼，然後按 ENTER 鍵。
- 4 用數字鍵重新輸入一遍密碼進行確認，然後按 ENTER 鍵。

## 播放設有用戶鎖定的光碟

- 1 裝入有用戶鎖定設定的光碟。  
出現用戶鎖定顯示畫面。

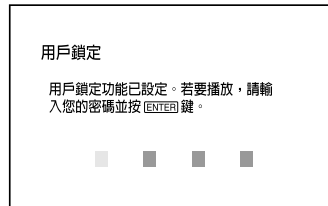

- 2 用數字鍵輸入 4 位數密碼，然後按 ENTER 鍵。

接收機已作好播放準備。

💡 如果您忘記密碼，當顯示用戶鎖定顯示畫面要求您輸入密碼時，用數字鍵輸入“199703”6 位數，然後按 ENTER 鍵。隨後會顯示要求您輸入新的 4 位數密碼。

## 限制兒童播放（視聽者年齡控制）

DVD

根據預先設置碟片的播放級別，如使用者的年齡來限制播放某些碟片。“視聽者年齡控制”功能允許您設置播放限制級別。

被限制場面不被播放，或由其他場面取代。

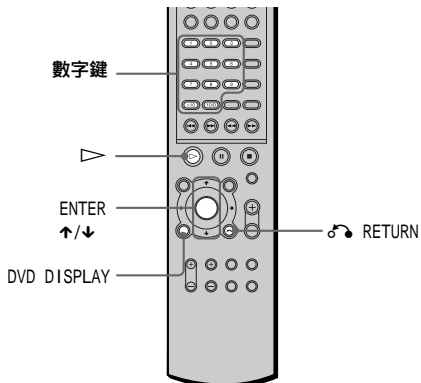

1 在停止模式下，按 DVD DISPLAY 鍵。  
出現設置顯示。

2 按 ↑/↓ 鍵選擇“個人設定”，然後按 ENTER 鍵。  
顯示“個人設定”。

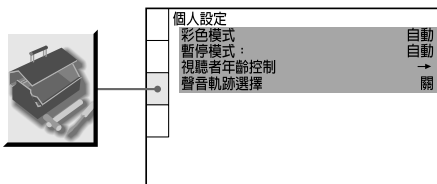

3 按 ↑/↓ 鍵選擇“視聽者年齡控制”，再按 ENTER 鍵。

■如果還未設過密碼  
出現要求註冊新密碼的顯示。

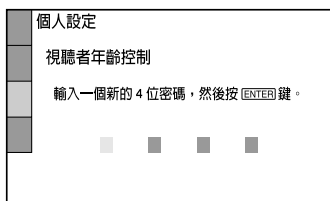

用數字鍵輸入 4 位數新密碼後，  
按 ENTER 鍵。  
隨後出現要求確認密碼顯示。

■如果已經註冊過密碼  
出現要求輸入密碼顯示。

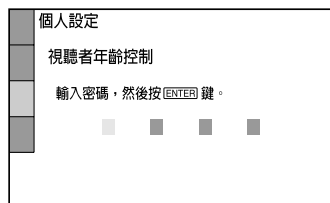

4 用數字鍵輸入或重新輸入密碼，然後按 ENTER 鍵。  
出現設置播放限制級別及改變密碼的顯示。

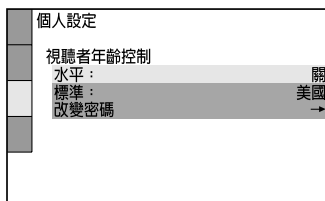

5 按 ↑/↓ 鍵選擇“標準”，然後按 ENTER 鍵。  
顯示“標準”選項。

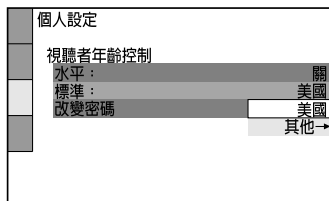

6 按 ↑/↓ 鍵選擇地理區域作為播放限制級別，然後按 ENTER 鍵。  
地區已選擇。  
如果選擇“其他”，用數字鍵選擇和輸入第 56 頁表中的標準代碼。



## 7 按 ENTER 鍵。

顯示“水平”的選項。

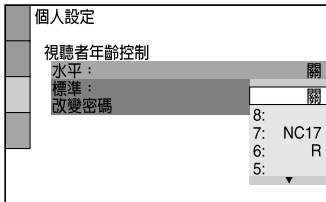

## 8 用 ↑/↓ 鍵選擇所需的級別，然後按 ENTER 鍵。

視聽者年齡控制設定完成。

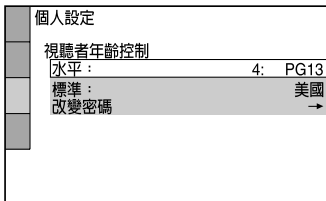

數值越低限制越嚴格。

### 如果操作有誤

按  RETURN 鍵前一屏幕顯示。

### 要關閉設定顯示

反覆按 DVD SETUP 鍵直到關閉設定顯示。

### 關閉視聽者年齡控制功能並在輸入密碼後播放 DVD

在第 8 步中將“水平”設定為“關”。

### 改變密碼

1 在第 5 步中，用 ↓ 鍵選擇“改變密碼”，然後按 ENTER 鍵。

出現要求輸入密碼的顯示。

2 按第 3 步輸入一新的密碼。

## 播放已設定視聽者年齡控制的光碟

### 1 裝入光碟，按 ▷ 鍵。

出現視聽者年齡控制顯示。

### 2 用數字鍵輸入 4 位數密碼，然後按 ENTER 鍵。

接收機開始播放。

 如果您忘記了密碼，取出光碟並重複“限制兒童播放”中的步驟 1 至 5，當要求輸入密碼時，用數字鍵輸入“199703”，然後按 ENTER 鍵。此時會顯示要求您輸入新的 4 位數密碼。在第 3 步中輸入 4 位數新密碼後，把光碟重新放入接收機並按 ▷ 鍵。當出現視聽者年齡控制顯示時，輸入新密碼。

### 注意

- 當播放無視聽者年齡控制功能的 DVD 時，本接收機無法限制播放。
- 對於不同的 DVD，當您播放時可能會要求改變視聽者年齡控制等級。出現這種情況，請輸入密碼，然後改變等級。如果取消繼續播放模式，就會恢復到原來的等級。

## 地區代碼

標準	代碼	標準	代碼
阿根廷	2044	挪威	2379
澳大利亞	2047	葡萄牙	2436
奧地利	2046	日本	2276
巴基斯坦	2427	瑞典	2499
巴西	2070	瑞士	2086
比利時	2057	泰國	2528
丹麥	2115	台灣	2543
德國	2109	西班牙	2149
俄羅斯	2489	香港	2219
法國	2174	新加坡	2501
菲律賓	2424	新西蘭	2390
芬蘭	2165	意大利	2254
韓國	2304	印度	2248
荷蘭	2376	印度尼西亞	2238
加拿大	2079	英國	2184
馬來西亞	2363	智利	2090
墨西哥	2362	中國	2092

## 用遙控器控制電視機

通過調整遙控信號，則可以用附帶的遙控器控制電視機。

### 注意

- 如果輸入新的代碼，以前輸入的代碼就會被抹去。
- 更換遙控器電池時，代碼可能會復位為默認 (Sony) 值。重新設置合適的代碼值。

### 使用遙控器控制電視機

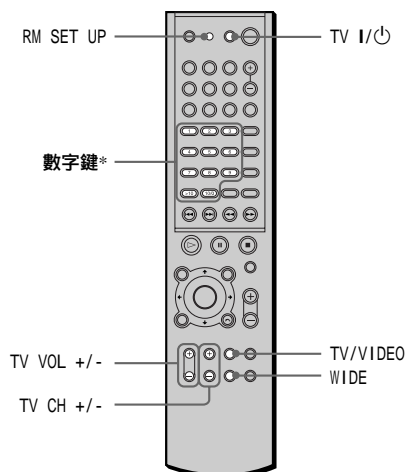

**1** 按住 RM SET UP 鍵的同時按 TV I/II 鍵。  
SET UP 指示燈點亮。

**2** 用數字鍵輸入電視機製造商代碼 (參見列表)。  
SET UP 指示燈閃爍兩次。

### 可遙控電視機的代碼值

如果列出的可選代碼不止一個，請逐個輸入，直到找到對您電視機有效的代碼。

### 電視機

生產商	代碼號
AIWA	17
AKAI	22
AOC	22
CENTURION	28
COLONAD	21
CURTIS-MATHES	28
Daytron	28
EMERSON	21, 22, 30
FISHER	27
FUJITSU	11
FUNAI	14
General Electric	24, 26
GOLD STAR (LG)	21, 22, 32
GRUNDIG	44
HITACHI	04, 21, 51
J.C.Penney	22, 28
JVC	06
KMC	21
LOEWE	56
MAGNAVOX	21, 25, 28
MARANTZ	22, 29
MGA/MITUBISHI	22, 28, 29, 32
NEC	09, 22, 28
NOKIA	47, 48, 58
PANASONIC (MATSUSHITA)	02, 13, 24, 57
Philico	21, 22
PHILIPS	25, 34, 41, 42, 43
PIONEER	10
Portland	21
QUASAR	08, 24
RADIO SHACK	23, 30
RCA	22, 26
SABA	45, 46
SAMPO	28
SAMSUNG	18, 33, 49, 50
SANYO	07, 15, 27, 52
SCOTT	28
SEARS	03, 26, 27
SHARP	08, 16, 21, 23
SONY	01 (default), 12
SYLVANIA	25, 28
TEKNIKA	21, 25, 30
TELEFUNKEN	53
THOMSON	55
TOSHIBA	03, 54
WARDS	21, 22, 28
YORX	28
ZENITH	31

## 控制電視機

您可以使用以下鍵來控制電視機。

按下	可以
TV I/⏻ 鍵	打開或關閉電視機。
TV/VIDEO 鍵	在電視機和其它輸入源中轉換電視機的輸入源。
TV VOL +/- 鍵	調節電視機音量。
TV CH +/- 鍵	變換電視機聲道。
WIDE 鍵	變換電視機的縱橫比。

### 注意

對於不同的電視機，有的可能無法控制，或者以上某些鍵無法使用。

\* 僅能使用數字鍵輸入可控制電視機的代碼。

## 觀看圖像或其它裝置

可以將錄影機或其它裝置連接到 VIDEO(S VIDEO/AUDIO L/R IN/OUT) 插孔。更多操作資訊請查閱該裝置所附帶的操作手冊。

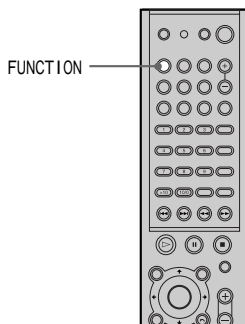

反覆按下 FUNCTION 鍵，直到連接有裝置的“VIDEO”插孔出現在前面板顯示幕內。

每按一次 FUNCTION 鍵，接收機模式按如下順序改變：

DVD → VIDEO → TV/SAT → AUX → MD/  
DAT → TUNER → DVD...

### 注意

您可以按 FUNCTION 鍵並選擇所連接的輸入訊號，來收聽連接在接收機上的其它裝置（卡座、衛星調諧器等）。

# 收聽無線電台

首先將電台預先設置在接收機的記憶體中（參看第 28 頁的“預設電台”）。

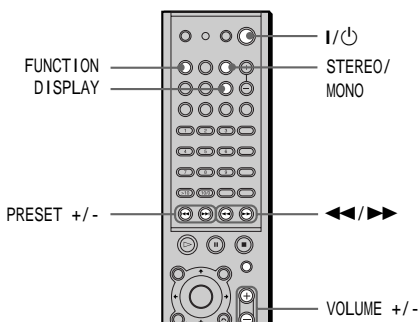

**1** 反覆按 FUNCTION 鍵直到 TUNER 選單出現在前面板顯示幕內。  
最後一次接收的電台調入。

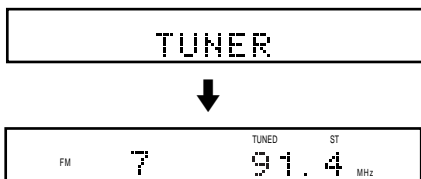

**2** 反覆的按 PRESET + 或 PRESET - 鍵，選擇想要的預置電台。  
每按一次鍵，接收機就調入一個電台。

**3** 按 VOL +/- 鍵調節音量。

要關閉收音機。  
按 I/⏻ 鍵。

## 要收聽未預置的電台

在步驟 2 中用手動或自動調諧。反覆按遙控器上的 << 或 >> 鍵進行手動調諧。

按住遙控器上的 << 或 >> 鍵進行自動調諧。

**💡** 如果 FM 節目出現噪聲

按遙控器上的 STEREO/MONO 鍵，使在前面板顯示幕中出現 MONO，立體聲效果消失，但接收效果有改善，再按一下此鍵可恢復立體聲效果。

**💡** 提高接收效果

重新定位天線。

## 查看頻率或聲場

反覆按 DISPLAY 鍵。

每按一次 DISPLAY 鍵，前面板顯示幕將按下列順序變化：

電台索引名稱 → 頻率 → 聲場 → 電台索引名稱

## 為預置電台命名

您可以為已預置的電台輸入最多 8 個字符的名稱。當選擇一個電台後，這些名稱（如“XYZ”）將出現在接收機前面板顯示幕上。

注意每個預置電台只可輸入一個名稱。

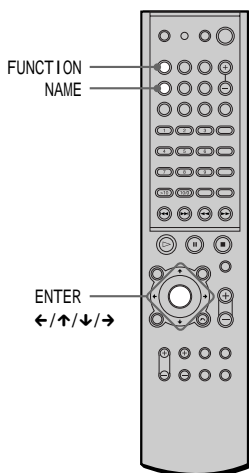

- 1** 反覆按 FUNCTION 鍵，直到 TUNER 出現在前面板顯示幕上。

最後一次接收的電台被調入。

每按一次 FUNCTION 鍵，接收機模式就按下列順序改變：

DVD → VIDEO → TV/SAT → AUX  
→ MD/DAT → TUNER → DVD...

- 2** 調入想要為其建立名稱索引的預置電台。

如果您不熟悉如何調入預置電台，參看第 61 頁的“收聽無線電台”。

- 3** 按 NAME 鍵。

- 4** 用箭頭鍵建立名稱索引。

按 ↓/↑ 鍵選擇一個字，然後按 → 鍵移動光標到下一個位置。

如果操作有誤

反覆按 ← 或 → 鍵直到要更改的字符閃爍，然後按 ↓/↑ 鍵選擇正確的字符。

- 5** 按 ENTER 鍵。

要給其它電台定義索引名稱

重複步驟 2 至 5。

# 使用設定顯示



使用設定顯示，能對圖像和聲音等項目做各種調整。您也能為字幕和設定顯示設置一種語言及其它內容。在第 62 - 68 頁將詳細介紹每一個設定顯示項目。有關設定顯示項目的總清單，請看第 78 頁。

## 如何使用設定顯示

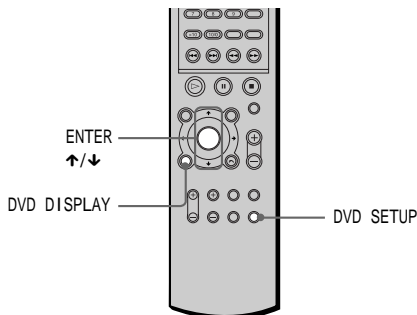

- 1 在停止模式下，按 DVD DISPLAY 鍵。  
出現控制選單。  
如果按 DVD SETUP 鍵，將直接進入步驟 3。
- 2 按 ↑/↓ 鍵選擇  (設定) 然後按 ENTER 鍵。  
有關設置的選擇項將出現。

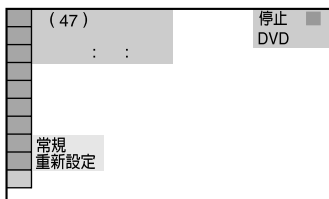

- 3 按 ↑/↓ 鍵選擇“常規”然後按 ENTER 鍵。  
出現設定顯示。

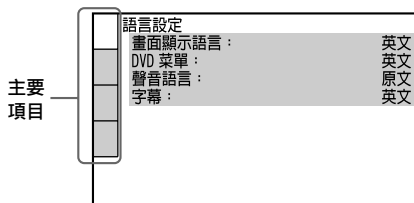

- 4 按 ↑/↓ 鍵從顯示列表：“語言設定”、“畫面設定”、“個人設置”和“揚聲器設定”中選擇設置項目，然後按 ENTER 鍵。  
已選擇的設定項目出現。  
例如“畫面設定”

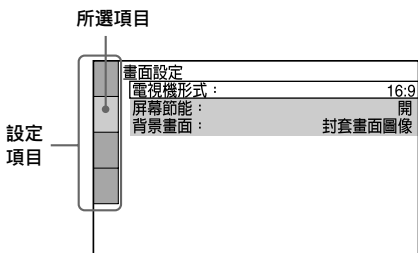

5 按  $\uparrow/\downarrow$  鍵選擇一個項目，然後按 ENTER 鍵。

出現已選擇的項目。  
例如：“電視機形式”

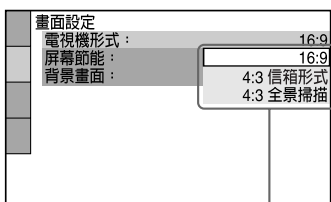

選項

6 按  $\uparrow/\downarrow$  鍵選擇一個設定，然後按 ENTER 鍵。

此設定已選擇並完成設定。  
例如：“4:3 全景掃描”

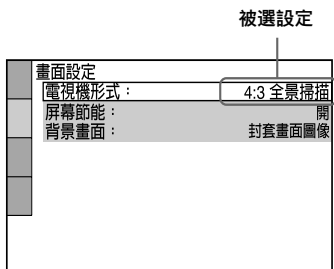

## 要關閉設定顯示

反覆的按 DVD SETUP 或 DVD DISPLAY 鍵，直到設定顯示關閉。

 如果在步驟 2 中選擇“重新設定”，您能將第 80 頁中所有“設定”中的設定項目重新設定為默認設定（除視聽者年齡控制）。在您選擇“重新設定”並按 ENTER 鍵後選擇“是”，則可重新設定所有的設置（這需要幾秒鐘完成），或選擇“不”並且按 ENTER 鍵回到控制選單。當重新設定接收機時，切勿按 POWER 鍵或  $I/\circlearrowleft$  鍵。

## 設定顯示或聲音軌跡語言（語言設定）



“語言設定”可使您對屏幕顯示或聲音軌跡設置各種語言。

在設置顯示中選擇“語言設定”。關於怎樣用顯示的更詳細介紹，參看“使用設定顯示”（第 63 頁）。

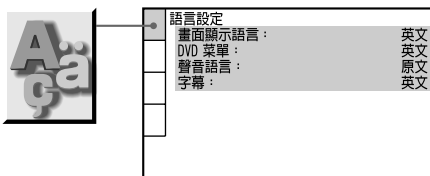

### ■畫面顯示語言（屏幕顯示）

在屏幕上轉換顯示語言。  
從顯示選單中選擇語言。

### ■DVD 菜單（僅用於 DVD）

為 DVD 選單選擇所要的語言。

### ■聲音語言（僅用於 DVD）

轉換聲音軌跡語言。從顯示選單中選擇語言。當您選擇“原文”時，則選擇了光碟中優先給出的語言。

### ■字幕（僅用於 DVD）

轉換字幕語言。從顯示選單中選擇語言。當您選擇“聲音運動”選項時，字幕語言變化取決於您為聲音軌跡選擇的語言。



💡如果您在“DVD 菜單”、“字幕”、或“聲音語言”中選擇了“其他 →”，您就可以用數字鍵從列表中選擇並輸入語言代碼（第 79 頁）。當作出選擇後，下次您選擇“其他 →”時將顯示此語言代碼（4 位數字）。

### 注意

如果您選擇的一種語言在 DVD 中沒有被錄製，那麼其中一種被錄製的語言將被自動選中（除“畫面顯示語言”外）。

## 顯示設定（畫面設定）



按照連接的電視機選擇設置。

在設定顯示中選擇“畫面設定”。有關使用顯示的詳細說明參看“使用設定顯示”（第 63 頁）。

默認設定有下列線。

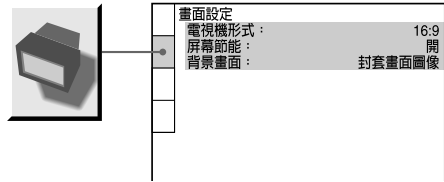

### ■ 電視機形式（僅用於 DVD）

選擇與 DVD 相連接電視機的外觀比率（4：3 標準或寬屏）。

默認設定依據所在國家的機型而不同。

16:9	當您所連接的電視機是寬屏幕或具有寬模式功能時，選擇此項。
4:3 信箱形式	當您所連接的電視機屏幕的比率是 4：3 時，選擇此項。顯示寬畫面，並且在屏幕上部和下部有帶邊。
4:3 全景掃描	當連接 4：3 屏幕電視機時選擇此項。在整個屏幕上自動顯示寬畫面，並切除無法顯示到的部分。

16:9



4:3 信箱形式



4:3 全景掃描

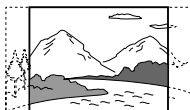

### 注意

在有的 DVD 中，“4:3 信箱形式”會被自動選取，從而代替“4:3 全景掃描”，反之亦然。

### ■ 屏幕節能

打開和關閉屏幕節能使接收機在處於暫停或處於停止模式達 15 分鐘，或播放 CD 超過 15 分鐘時，出現屏幕節能圖像。屏幕節能可防止顯示設備受到損壞，按下  $\blacktriangleleft$  鍵則關閉屏幕節能。

開	打開屏幕節能。
關	關閉屏幕節能。

### ■ 背景畫面

在停止模式或正在播放 CD 時，可以為電視屏幕選擇背景顏色或圖片。

封套畫面 圖像	只有當光碟中已錄有此封套畫面圖像（靜止圖片）時，才會出現背景畫面，如果光碟中不含有封套畫面圖像，此時將出現“圖形”畫面。
圖形	儲存系統中的一個預設畫面出現在背景上。
藍色	背景是藍色。
黑色	背景是黑色。

## 個人設定 (個人設定)



允許建立視聽者年齡控制和其它設定。

在設定顯示中選擇“個人設定”。  
有關使用顯示的詳細說明參看“使用設定顯示”(第 63 頁)。  
有下劃線的為默認設定。

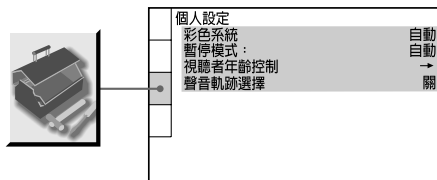

### ■ 播放 VIDEO CD 的彩色系統

當播放 VIDEO CD 時選擇彩色系統。

自動	對 PAL 或 NTSC，均輸出光碟系統中的圖像信號。如果您的電視機是 DUAL 系統，請選擇自動。
PAL	改變 NTSC 光碟的視頻信號，並在 PAL 系統中的輸出。
NTSC	改變 PAL 光碟中的圖像信號並在 NTSC 系統中輸出。

### 注意

- 您不能改變光碟自身的彩色系統。
- 對亞洲機型或澳大利亞機型，您能根據相連接的電視機改變裝置的彩色系統。見第 22 頁。

## ■暫停模式（僅對 DVD）

選擇暫停模式下的圖片。

自動	輸出含有移動物體的動感畫面，且無圖象抖動。正常情況下就選擇此項。
幀	以高清晰度輸出含有無動感物體的畫面。

## ■視聽者年齡控制 →（僅對 DVD）

對 DVD 設定密碼和播放限制等級，以對兒童播放進行限制。要獲得更詳細地了解，參看“限制兒童播放（視聽者年齡控制）”（第 55 頁）。

## ■聲音軌跡選擇（僅對 DVD）

當播放一張記錄有多種音頻格式（PCM, MPEG 音頻, DTS, 或者杜比數碼格式）的 DVD 光碟時，具有最高聲道數的聲音軌跡有優先權。

關	沒有得到優先權。
自動	得到優先權。

## 注意

- 當項目設定為“自動”時，可以改變語言。在“語言設定”中，“聲音軌跡選擇”設定比“聲音語言”設定具有更高的優先級（第 64 頁）。
- 如果 PCM、DTS、MPEG 音頻，以及杜比數字等聲音軌跡有相同的聲道數，接收機會依次選擇 PCM、DTS、杜比數字，以及 MPEG 音頻的聲音軌跡。
- 根據 DVD 光碟的不同，接收機預先選定音頻聲道為優先。此時，您不能通過選擇“自動”，使 DTS、杜比數字，或者 MPEG 音頻聲音格式獲得優先級。

## 揚聲器的設定（揚聲器設定）

為獲得最佳的環繞聲，必須對已連接的揚聲器設定尺寸和距收聽位置的距離。然後用測試音調整揚聲器音量和平衡至相同水平。

在設定顯示中選擇“揚聲器設定”。詳細說明參看“使用設定顯示”（第 63 頁）。

下劃線部分為默認設定。

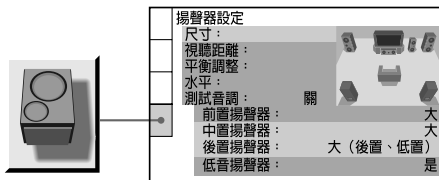

## 要回到默認設定

選擇這一項，然後按 CLEAR 鍵。

## ■尺寸

當您未連接中置或後置揚聲器，或搬動後置揚聲器時，須設定前置揚聲器中置揚聲器，後置揚聲器和低音揚聲器參數。下劃線部分為默認設定。

### • 前置揚聲器

- 大：一般情況下選擇此項。
- 小：如果小型揚聲器用作前置揚聲器則選擇此項。

### • 中置揚聲器

- 大：一般情況下選擇此項。
- 小：如果小型揚聲器用作中置揚聲器則選擇此項。
- 無：如果不使用中置揚聲器則選擇此項。

• 後置揚聲器

- 大（後置，低置），大（後置，高置），大（側置，低置），大（側置，高置），小（後置，低置），小（後置，高置），小（側置，低置），小（側置，高置）：確定位置和高度可以正確地實現“虛擬”聲場（第48頁）中的“數字影院環繞”模式。
- 無：如果不使用後置揚聲器則選擇此項。

• 低音揚聲器

- 是：如果使用低音揚聲器則選擇此項。
- 無：如果不使用低音揚聲器則選擇此項。

**注意**

- 當您選擇某一項目時，聲音會停止片刻。
- 根據其它揚聲器的設定，低音揚聲器可能產生過大的聲音。

**確定後置揚聲器的位置和高度**

如果您在“後置揚聲器”選項中選取“無”，則可確定後置揚聲器的位置和高度。有下列劃線為默認設定。

大（後置、低置） 小（後置、低置）	如果後置揚聲器位於 <b>B</b> 和 <b>D</b> 時選擇此項。
大（後置、高置） 小（後置、高置）	如果後置揚聲器位於 <b>B</b> 和 <b>C</b> 時選擇此項。
大（側置、低置） 小（側置、低置）	如果後置揚聲器位於 <b>A</b> 和 <b>D</b> 時選擇此項。
大（側置、高置） 小（側置、高置）	如果後置揚聲器位於 <b>A</b> 和 <b>C</b> 時選擇此項。

當“後置揚聲器”設定為“無”時，這些參數不能使用。

位置圖

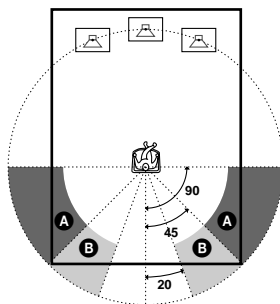

高度圖

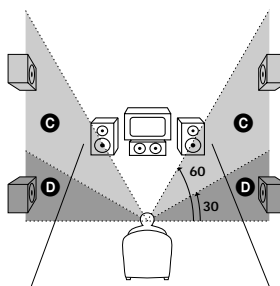

■ 視聽距離

揚聲器默認距離的設定與以下圖示的收聽位置有關。

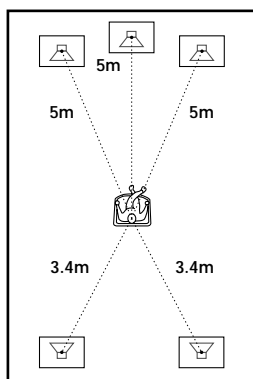

當移動揚聲器時一定要改變設定顯示中的值。默認設定有下列劃線。

前置揚聲器 (5m)	前置揚聲器距收聽者的距離範圍為 1.0 到 15m，設定以 0.2m 遞增。
中置揚聲器 (5m)	中置揚聲器距離可以朝收聽位置移動至 1.6m，移動以 0.2m 遞增。
後置揚聲器 (3.4m)	後置揚聲器的距離從前置揚聲器位置起向收聽位置最多移動 4.6m，移動以 0.2m 遞增。

### 注意

- 當您設置距離時，聲音會停止片刻。
- 如果每個前置或後置揚聲器未放置在距收聽位置相等的距離，請按照最近的揚聲器設定距離。
- 不要將後置喇叭放置在比前置揚聲器距收聽位置更遠的位置。

### ■ 平衡調整

您能如下改變左右揚聲器間的平衡。確保把“測試音調”設置為“開”，以方便調整。

有下列劃線為默認調整。

前置揚聲器 (中心)	調整前置左右揚聲器間的平衡 (您能從中心 6 級向左或右調整)。
後置揚聲器 (中心)	調整後置左右揚聲器間的平衡 (您能從中心 6 級向左或右調整)。

### ■ 水平

您能如下改變每個揚聲器的水平。確保使“測試音調”設定為“開”，以便容易調整。

默認設定有下列線。

中置揚聲器 (0dB)	調整中置揚聲器的水平。(從 -10dB 至 +10dB，以 1dB 遞增)。
後置揚聲器 (0dB)	調整後置揚聲器的水平。(從 -10dB 至 +10dB，以 1dB 遞增)。
低音揚聲器 (0dB)	調整低音揚聲器的水平。(從 -10dB 至 +10dB，以 1dB 遞增)。

### 一次性調整所有揚聲器的音量

使用 VOLUME 鍵控制。

### ■ 測試音調

揚聲器將發出測試音調來調整“平衡”和“水平”。

關	揚聲器不發出測試音調。
開	調整平衡和水平時，每個揚聲器依次發出測試音調。當您選擇“揚聲器設定”中某一項時，左右兩個揚聲器同時發出測試音調。

## 調整揚聲器音量和水平

- 1** 在您停止播放後，按下設定顯示中的 DVD SETUP 鍵後選擇“揚聲器設定”。
- 2** 選擇“測試音調”並將“測試音調”設置為“開”。  
您能依次聽到來自各個揚聲器的測試音調。
- 3** 在收聽位置處，選擇“平衡調整”或“水平”，然後用 ↑/↓ 鍵調整“平衡調整”值和“水平”值。  
左右揚聲器同時發出測試音調。
- 4** 選擇“測試音調”並把“測試音調”設置為“關”，以關閉測試音調。

### 注意

當您調整揚聲器設定時，聲音會停止片刻。

## 故障排除

如果您在使用本接收機時遇到下列困難，在請求修理之前，可以用此故障排除指南來解決問題。如果問題仍存在，請諮詢離您最近的索尼銷售商。

### 電源

電源未打開。

- ➔ 檢查電源插頭（幹線導線）是否完全的插入插座。

### 圖像

無圖像。

- ➔ 連接線未完全連接。
- ➔ 連接線損壞。
- ➔ 接收機未連接到正確的電視機輸入插孔（第 21 頁）。
- ➔ 電視機未設定為視頻輸入，以致無法觀看來自本接收機的圖像。

出現圖像雜波。

- ➔ 光碟髒或有裂紋。
- ➔ 如果通過 VCR 將圖像從本接收機輸出至電視機，某些 DVD 節目上採用的版權保護信號能影響圖像的品質。

即使在“畫面設置”的“電視機形式”中設置了外觀比率，圖像仍不能充滿整個屏幕。

- ➔ 說明您的 DVD 已經鎖定光碟的外觀比率。

畫面是黑白圖像。

- ➔ 當播放以 NTSC 制式錄製的光碟，屏幕上的圖像會由於電視機的不同而變為黑白。

### 聲音

無聲音。

- ➔ 連接線未完全連接。
- ➔ 連接線損壞。
- ➔ 如果前面板顯示幕中顯示了“MUTING ON”，請按一下遙控器上的 MUTING 鍵。
- ➔ 接收機的保護裝置由於短路被啟動。關閉統，清除短路，再重新打開電源。
- ➔ 音頻連接線損壞。  
更換新的音頻連接線。
- ➔ 接收機處於暫停或慢進播放模式，按 ▷ 鍵回到正常播放模式。
- ➔ 正在進行快進或快倒。  
按 ▷ 鍵回到正常播放模式。
- ➔ 檢查揚聲器的設定（第 23、67 頁）。

左右聲音不平衡或顛倒

- ➔ 檢查揚聲器和部件間連接是否正確和完全。
- ➔ 調整 LEVEL 選單中的前置平衡參數（第 26，69 頁）。

聽到嚴重的嗡嗡聲或噪聲。

- ➔ 檢查揚聲器和部件間連接是否完全連接。
- ➔ 檢查連接線是否遠離變壓器或馬達，並使連接線遠離電視機或熒光燈至少 3 米。
- ➔ 使電視機遠離音頻部件。
- ➔ 插頭和插孔髒污，用帶有酒精的濕布擦洗。
- ➔ 清潔光碟。

播放 VIDEO CD 或 CD 碟片時立體聲效果丟失。

- ➔ 在控制選單顯示中設置“聲音語言”為“立體聲”（第 44 頁）。
- ➔ 確認已將接收機連接正確。

---

**當播放杜比數碼聲音軌跡時，聽不到環繞效果。**

- ➔ 檢查是否開啟聲場功能（第 46 頁）。
- ➔ 檢查揚聲器連接和設定（第 16、23、67 頁）。
- ➔ 有些 DVD 即使是以杜比數碼格式錄製的聲音軌跡，輸出的信號卻不是完全 5.1 聲道，而是單聲道或立體聲。

---

**當播放杜比數碼或 MPEG 音頻聲音軌跡時聽不到環繞效果。**

- ➔ 檢查揚聲器連接和設定（第 16、23、67 頁）。
- ➔ 有些 DVD 即使是以有杜比格式或以 MPEG 音頻格式錄製的聲音軌跡，輸出的信號不完全是 5.1 聲道，而是單聲道或立體聲。

---

**僅中置揚聲器有聲音。**

- ➔ 有的光碟聲音只來自於中置揚聲器。

---

**中置揚聲器沒有聲音。**

- ➔ 確認聲場功能是否開啟（第 46 頁）。
- ➔ 選擇含有“CINEMA”和“VIRTUAL”單詞的聲場（第 46 頁）。

---

**後置揚聲器沒有聲音或音量很小。**

- ➔ 確認聲場功能是否開啟（第 46 頁）。
- ➔ 選擇含有“CINEMA”和“VIRTUAL”單詞的聲場（第 46 頁）。

## 操作

---

**無法調入無線電台。**

- ➔ 確認天線是否連接正確。調整天線，必要時連接室外天線。
- ➔ 電台信號強度太弱（自動調諧時）。直接手動調諧。
- ➔ 未預設電台或預設電台已被清除（使用掃描調諧預設電台時）。請重新預設電台（第 28 頁）。
- ➔ 按 DISPLAY 鍵顯示頻率。

---

**遙控器失靈。**

- ➔ 遙控器和接收機之間是否有障礙物。
- ➔ 遙控器與接收機距離太遠。
- ➔ 遙控器沒有對準接收機的遙控感應器。
- ➔ 遙控器電池能量變弱。

---

**光碟無法播放。**

- ➔ 沒有放入光碟。
- ➔ 碟片放反了。  
把碟片播放面向下裝入光碟托架。
- ➔ 光碟未放正。
- ➔ 接收機不能播放 CD - ROM 等（第 7 頁）。
- ➔ DVD 區域編碼與接收機不相符。
- ➔ 接收機受潮。  
取出碟片，讓接收機通電約半小時（第 3 頁）。



---

### 光碟未從開頭播放。

- ➔ 已選擇程序播放，隨機播放或重複播放功能（第 34-37 頁）。  
在播放光碟前按 CLEAR 鍵取消這些功能。
- ➔ 已選擇重新播放功能。  
在停止狀態中，按接收機上或遙控器上的 ■ 鍵然後開始播放 DVD（第 31 頁）。
- ➔ 標題，DVD 或 PBC 選單自動出現在電視機屏幕上。

---

### 接收機開始自動播放光碟。

- ➔ DVD 執行自動播放功能。

---

### 播放自動停止。

- ➔ 某些碟片可能含有自動暫停信號。播放此種碟片時，接收機會在自動暫停信號處停止播放。

---

### 不能執行下列這些功能：如停止、尋找、慢放、重複播放、隨機播放或程序播放。

- ➔ 有的光碟可能無法執行上述一些操作。參看隨光碟附帶的操作手冊。

---

### 資訊未以您想要的語言顯示。

- ➔ 在設定顯示中，在“畫面顯示語言”下的“語言設定”內選擇需要的屏幕顯示語言（第 64 頁）。

---

### 聲音軌跡語言無法改變。

- ➔ 正在播放的 DVD 未錄製多語言軌跡的功能。
- ➔ 此 DVD 禁止改變聲音軌跡語言。

---

### 字幕語言無法改變。

- ➔ 正在播放的 DVD 未錄製多語言字幕。
- ➔ 此 DVD 禁止改變字幕。

---

### 字幕無法關閉。

- ➔ 此 DVD 禁止關閉字幕。

---

### 無法改變角度。

- ➔ 正在播放的 DVD 未錄製多角度。只有位於前面板顯示幕的“角度”指示燈亮時，才能改變角度。
- ➔ 此 DVD 禁止改變角度。

---

### 接收機無法正確運行。

- ➔ 如果靜電干擾等原因使接收機不能正常的運行，請按接收機上的 POWER 鍵使接收機關閉，然後再開啟。

---

### 前面板顯示幕沒有任何顯示。

- ➔ 按遙控器上的 DIMMER 鍵。

---

### 5 個字符的維修號碼出現在屏幕和前面板顯示幕內。

- ➔ 自檢功能被激活（見第 74 頁中的表）。

---

### 光碟托架不能打開，並且 LOCKED 字樣顯示在前面板顯示幕內。

- ➔ 請與 Sony 銷售商或當地授權的 Sony 服務機構聯繫。

---

### “PROTECT”出現在前面板顯示幕上。

- ➔ 揚聲器保護電路起作用。請檢查揚聲器連接。

## 自檢功能 (顯示中出現字母/數字時)

自檢功能激活時能防止接收機出現故障。在這種情況下，屏幕和前面板顯示幕上將顯示一個 5 個字符的服務編號 (如：C13 00)。參看下表。

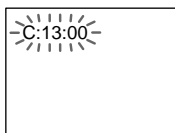

維修編號的 前 3 個字符	原因和/或糾正方法
C 13	光碟髒污。 ➔ 用軟布清洗光碟 (第 8 頁)。
C 31	光碟沒有正確的放入。 ➔ 重新正確放入光碟。
E XX (XX 為數字)	為了防止出現故障，接收機執行自檢功能。 ➔ 與最近的 Sony 銷售商或當地授權的服務部門聯繫，並提供一個 5 位數的服務編號。 如：E61 10

## 術語

### 比特速率

其值表明一個 DVD 每秒壓縮圖像數據的數量，其單位是 Mbps (兆比特每秒)。1 Mbps 相等於每秒的數據是 1,000,000 比特。比特速率越高，數據量越大。但是，這不等於您能獲得高品質的圖像。

### 標題

DVD 光碟上的一段畫面或一段音樂的最長部分；在視頻軟體上的電影等畫面片段；或者在音頻軟體上的整個專輯等。每個標題配有一個標題號碼，可用來查找您想要的標題。

### 播放控制 (PBC)

VIDEO CD (2.0 版本) 上的加密信號可以控制播放。

使用帶 PBC 功能的 VIDEO CD 上記載的屏幕選單，您可以享受簡單的交互式程序，這種程序里有查找和其它功能。

### 超級音頻 CD (Super Audio CD)

這種音頻格式基於當前的音頻 CD 標準，但它包括能提供更高品質聲音的更大量的資訊。有三種類型的光碟：單層、雙層和混和型。混合型的光碟包括標準的音頻 CD 和超級音頻 CD 兩種資訊。

---

## 場面

在有 PBC (播放控制) 功能的 VIDEO CD 上, 選單螢幕、運動影像和靜止影像都被分成許多部分, 稱為“場面”。

---

## 地區代碼

本接收機可以保護版權。根據銷售地區的差異每個 DVD 接收機或 DVD 光碟中都分配有一個地區代碼。每地區代碼都註明在接收機中或光碟的包裝上。本接收機能播放與地區代碼一致的光碟。也能播放帶有  標記的光碟。即使地區代碼沒有在 DVD 上標出, 地區限定仍可能被啟動。

---

## DTS (數碼劇院系統)

數碼音頻壓縮技術是由數碼劇院系統公司開發的。這種技術符合 5.1 聲道環繞。後置聲道是立體聲, 並且在這種格式下有一個分立的低音揚聲器聲道。DTS 提供同樣高品質數字音頻 5.1 離散聲道。所有的聲道數據離散地錄製並數字化處理, 這樣可以獲得更佳的聲道分離效果。

---

## 杜比數碼

這種適合影院的聲音格式比杜比邏輯環繞更先進。在這種模式中, 後置揚聲器輸出有擴展頻率範圍的立體聲, 並且單獨提供用於超低音的低音揚聲器聲道, 這種格式也稱為 5.1, 因為低音揚聲器聲道被看作 0.1 聲道 (只有需要超低音效果時, 它才起作用)。這種格式中六個聲道被單獨錄製, 以形成良好聲道分離。此外, 因為所有信號都經數字化處理, 因此發生衰減的信號較少。

---

## 杜比專業邏輯環繞

作為一種編譯杜比環繞的方法, 杜比專業邏輯環繞能把兩聲道的聲音變為四聲道。相比以前的杜比環繞系統, 杜比專業邏輯環繞能更自然地再現從左到右的整個環繞效果, 可以更準確地定位聲音。要充分利用了杜比專業邏輯環繞, 您應該有一對後置揚聲器和一個中置揚聲器。後置揚聲器輸出單聲道聲音。

---

## 多角度功能

某些 DVD 能錄製一個場面的各角度或攝像機的各視點。

---

## 多語種功能

有些 DVD 中為聲音或圖像中的字幕而錄有幾種語言。

---

## DVD

與 CD 直徑相同的 DVD 光碟最多可容納 8 小時的動畫。

一張單層單面的 DVD 光碟容納的數據量是 4.7 GB, 是 CD 的 7 倍。此外, 一張雙層單面的 DVD 光碟容納的數據量是 8.5 GB, 一張單層雙面的 DVD 是 9.4 GB。雙層雙面的 DVD 是 17 GB。

該圖像數據使用數字壓縮技術中心的世界性標準之一的 MPEG 2 格式。圖像數據被壓縮成原始尺寸的 1/40。這種 DVD 也採用可變率代碼技術, 這種技術根據圖像的狀態, 改變已分配的數據。

音頻數據以杜比數碼以及 PCM 的形式被錄製, 以便您欣賞更真實的現場聲音。

此外, 這種類型 DVD 可以提供各種先進的功能如: 多角度、多語種和視聽者年齡控制。

---

## 軌跡

它是 CD 或 VIDEO CD 上的一副圖片或一個音樂片段的組成部分。每個軌跡用一個軌跡號標記，以便您查找所需的軌跡。

---

## 視聽者年齡控制

該 DVD 功能是根据每個國家的限制等級，對不同年齡的用戶對光碟的播放做出限制。不同光碟限制不同。限制激活時，禁止播放，暴力的場面可跳過去或用其它的場景代替等。

---

## 數碼影院聲音 (DCS)

它是環繞聲的同類名稱。環繞聲是由 Sony 公司研製的數碼信號處理技術來產生的，這種數字影院聲音不同以前那種旨在進行音樂複製的環繞聲場。

---

## 索引 (超級音頻 CD/CD) / 視頻索引 (VIDEO CD)

超級音頻 CD/CD 或 VIDEO CD 上將一個軌跡分成幾部分的數字，以用來方便地找到您想要的位置。根據光碟的不同，可能未錄製索引。

---

## VIDEO CD

具有動畫的壓縮盤。

這種圖片數據採用 MPEG 1 格式，它是數字壓縮技術的世界性標準之一。圖片數據被壓縮為原來的 1/140。因此，一張 12 厘米的 VIDEO CD 能包含最長為 74 分鐘的移動畫面。VIDEO CD 也含有壓縮音頻數據。人的聽力範圍外的聲音都被壓縮而聽力範圍內的則沒有壓縮。VIDEO CD 的音頻資訊容量是傳統的 CD 的 6 倍。

有兩個版本的 VIDEO CD 碟片。

版本 1.1: 您只可播放動畫和聲音。

版本 2.0: 能播放高分辨率的靜畫和體驗 PBC 功能。

本接收機適用於以上兩種版本。

---

## 章

DVD 光碟上的一段圖像或一段音樂部分，比標題小。一個標題由幾個章組成。每一章要用章節數標出，以便讓您查找您需要的章。

# 規格

## 放大器部分

立體聲模式

50 W + 50 W (1 kHz 時 6 歐姆, THD10%)

環繞模式

前置揚聲器 : 50 W + 50 W

中置揚聲器\* : 50 W

後置揚聲器\* : 50 W + 50 W (1 kHz 時 6 歐姆, THD10%)

\* 根據不同的聲場設定和音源, 可能沒有聲音輸出。

輸入 (模擬)

VIDEO IN, AUX IN :

靈敏度 : 150 mV

阻抗 : 50 千歐姆

輸入 (數字)

MD/DAT IN, TV/SAT IN OPTICAL :

靈敏度 : —

輸出 (模擬)

VIDEO OUT :

電壓 : 2 V

阻抗 : 1 千歐姆

SUBWOOFER AUDIO OUT :

電壓 : 3 V

阻抗 : 47 千歐姆

耳機 :

接受低和高阻抗的頭戴式耳機

輸出 (數字)

DIGITAL OUT OPTICAL (CD only) :

靈敏度 : —

## SACD/DVD 接收機

雷射

半導體雷射

( Super Audio CD/DVD :  $\lambda = 650 \text{ nm}$  )

( CD :  $\lambda = 780 \text{ nm}$  )

輻射持續時間 : 連續

信號格式系統

NTSC/PAL

頻率響應 (在 2 CH STEREO 模式下)

DVD (PCM) : 2 Hz 至 22 kHz ( $\pm 1.0 \text{ db}$ )

CD : 2 Hz 至 20 kHz ( $\pm 1.0 \text{ db}$ )

信噪比

大於 80dB (VIDEO 1 (AUDIO) 連接器)

諧波失真

小於 0.03%

## FM 調諧部分

系統

北美機型：

其它型號：

天線：

天線端子：

中頻：

PLL 石英鎖定數字合成系統。

87.5 - 108.0 MHz (100 kHz 步級)

87.5 - 108.0 MHz (50 kHz 步級)

FM 線天線

75 歐姆，非平衡

10.7 MHz

## AM 調諧部分

系統

調諧範圍

北美機型：

歐洲、中東和菲律賓機型：

其它型號：

天線

中頻：

調諧部分：

PLL 石英鎖定數字合成系統

530 - 1,710 kHz (間隔設定為 10 kHz)

531 - 1,710 kHz (間隔設定為 9 kHz)

531 - 1,602 kHz (間隔設定為 9 kHz)

531 - 1,602 kHz (間隔設定為 9 kHz)

530 - 1,710 kHz (間隔設定為 10 kHz)

環形天線

450 KHz

## 視頻部分

輸入

輸出

S - 視頻：

Y : 1Vp - p 75 歐姆

C : 0.286Vp - p 75 歐姆

S - 視頻：

Y : 1Vp - p 75 歐姆

C : 0.286Vp - p 75 歐姆

## 常規

電源要求

功率消耗

體積 (約)

質量 (約)

工作溫度

工作濕度

提供配件

230 V AC 50/60 Hz

105 W

430 × 82.5 × 376 mm (寬 × 高 × 深) 包括突出部分

4.3 kg

5 °C 至 35 °C

5% 至 90%

參見第 15 頁

設計和規格如有更改，恕不另行通知。

# 語言代碼列表

詳細介紹參看第 44, 52, 65 頁。  
這些語言拼寫符合 ISO639 : 1988 (E/F) 標準。

語言代碼	語言代碼	語言代碼	語言代碼
1027 Afar	1183 Irish	1347 Maori	1507 Samoan
1028 Abkhazian	1186 Scots Gaelic	1349 Macedonian	1508 Shona
1032 Afrikaans	1194 Galician	1350 Malayalam	1509 Somali
1039 Amharic	1196 Guarani	1352 Mongolian	1511 Albanian
1044 Arabic	1203 Gujarati	1353 Moldavian	1512 Serbian
1045 Assamese	1209 Hausa	1356 Marathi	1513 Siswati
1051 Aymara	1217 Hindi	1357 Malay	1514 Sesotho
1052 Azerbaijani	1226 Croatian	1358 Maltese	1515 Sundanese
1053 Bashkir	1229 Hungarian	1363 Burmese	1516 Swedish
1057 Byelorussian	1233 Armenian	1365 Nauru	1517 Swahili
1059 Bulgarian	1235 Interlingua	1369 Nepali	1521 Tamil
1060 Bihari	1239 Interlingue	1376 Dutch	1525 Telugu
1061 Bislama	1245 Inupiak	1379 Norwegian	1527 Tajik
1066 Bengali; Bangla	1248 Indonesian	1393 Occitan	1528 Thai
1067 Tibetan	1253 Icelandic	1403 (Afan)Oromo	1529 Tigrinya
1070 Breton	1254 Italian	1408 Oriya	1531 Turkmen
1079 Catalan	1257 Hebrew	1417 Punjabi	1532 Tagalog
1093 Corsican	1261 Japanese	1428 Polish	1534 Setswana
1097 Czech	1269 Yiddish	1435 Pashto; Pushto	1535 Tonga
1103 Welsh	1283 Javanese	1436 Portuguese	1538 Turkish
1105 Danish	1287 Georgian	1463 Quechua	1539 Tsonga
1109 German	1297 Kazakh	1481 Rhaeto- Romance	1540 Tatar
1130 Bhutani	1298 Greenlandic	1482 Kirundi	1543 Twi
1142 Greek	1299 Cambodian	1483 Romanian	1557 Ukrainian
1144 English	1300 Kannada	1489 Russian	1564 Urdu
1145 Esperanto	1301 Korean	1489 Russian	1572 Uzbek
1149 Spanish	1305 Kashmiri	1491 Kinyarwanda	1581 Vietnamese
1150 Estonian	1307 Kurdish	1495 Sanskrit	1587 Volapük
1151 Basque	1311 Kirghiz	1498 Sindhi	1613 Wolof
1157 Persian	1313 Latin	1501 Sangho	1632 Xhosa
1165 Finnish	1326 Lingala	1502 Serbo-Croatian	1665 Yoruba
1166 Fiji	1327 Laothian	1503 Singhalese	1684 Chinese
1171 Faroese	1332 Lithuanian	1505 Slovak	1697 Zulu
1174 French	1334 Latvian; Lettish	1506 Slovenian	
1181 Frisian	1345 Malagasy		1703 未說明

# DVD 設定選單列表

用 DVD 設定選單能設置下列項目。  
顯示項目的順序可能與實際選單略有不同。

## 語言設定

- 畫面顯示語言 (從顯示語言列表中选择要使用的語言)。
- DVD 菜單 (從顯示語言列表中选择要使用的語言)。
- 聲音語言 (從顯示語言列表中选择要使用的語言。當您選擇原文時，您能聽到光碟上最優先給出的語言)。
- 字幕 (從顯示語言列表中选择要使用的語言。當您選擇聲音運動時，設定被自動轉化成“聲音語言”中被選擇的語言)。

## 個人設定

- 彩色系統\*
  - 自動
  - PAL
  - NTSC
- 暫停模式
  - 自動
  - 幀
- 視聽者年齡控制
  - 水平
    - 關
    - 8.
    - 7. NC17
    - 6. R
    - 5.
    - 4. PG13
    - 3. PG
    - 2.
    - 1. G
  - 標準
    - 美國
    - 其它
- 聲音軌跡選擇
  - 改變密碼
  - 關
  - 自動

## 畫面設定

- 電視機形式
  - 16:9
  - 4:3 信箱形式
  - 4:3 全景掃描
- 屏幕節能
  - 關
- 背景畫面
  - 封套畫面圖像
  - 圖形
  - 蘭色
  - 黑色

## 揚聲器設定

- 尺寸
  - 前置揚聲器
    - 大小
  - 中置揚聲器
    - 大小
    - 無
  - 後置揚聲器
    - 大
      - 後置、低置
      - 後置、高置
      - 側置、低置
      - 側置、高置
    - 小
      - 後置、低置
      - 後置、高置
      - 側置、低置
      - 側置、高置
    - 無
  - 低音揚聲器 — 是 / 無
- 視聽距離
  - 前置揚聲器 — 1 15 米
  - 中置揚聲器 — 0 15 米
  - 後置揚聲器 — 0 15 米
- 平衡調整
  - 前置揚聲器 — 左或右各 6 級
  - 後置揚聲器 — 左或右各 6 級
- 水平
  - 中置揚聲器 — -10 +10dB
  - 後置揚聲器 — -10 +10dB
  - 低音揚聲器 — -10 +10dB
- 測試音調
  - 關
  - 開

\* 僅用於亞洲機型和澳洲機型。



# 索引

## 數字

- 16 : 9 65
- 4 : 3 全景掃描 65
- 4 : 3 信箱形式 65

## A

- AMP 選單 24

## B

- 背景畫面 66
- 編序播放 34
- 標題 6, 39, 74
- 標題選單 32
- 比特速率 53, 74
- 波段 28
- 播放模式 34

## C

- 彩色系統 66
- 操作光碟 8
- CD 30
- 測試音調 69
- 場面 6, 39, 175
- 尺寸 67
- 重複播放 36
- 重新播放 31
- 重新設定 64

## D

- DVD 32, 75
- DVD 選單 32, 64
- 地區代碼 7, 75
- 電池 16
- 電視機形式 65
- DTS 75
- 杜比邏輯環繞 75
- 杜比數碼 75
- 多角度功能 51
- 多語言功能 44

## G

- 個人設定 66
- 觀看電視機屏幕  
  查找特定點 38
- 軌跡 6, 39, 76
- 故障排除 71

## H

- 後面板 11
- 畫面設定 65
- 畫面顯示語言 64

## J

- 角度 51
- 靜音 31

## K

- 可用光碟 6
- 控制選單 13
- 控制選單顯示 13
- 快倒 38
- 快進 38
- 快速瀏覽 15

## L

- 連續播放  
  CD/VIDEO CD/  
  SACD/DVD 30

## M

- MEMORY 28
- 慢進播放 38
- 名稱 62

## P

- PBC 播放 33, 74
- 平衡調整 26, 69
- 屏幕節能 66

## Q

- 前面板 9
- 前面板顯示幕 10

## S

- S VIDEO 21
- SACD 74
- 掃描 38
- 設定顯示 61
- 聲場 46
- 聲音軌跡選擇 67
- 聲音語言 44, 64

- 時間 41
- 時間/文字 40
- 時間搜索 40
- 視聽距離 25, 68
- 視聽者年齡控制 55, 67, 76
- 水平 27, 69
- 隨機 36
- 隨機播放 36
- 索引 6, 39

## T

- 天線連接 19
- 調光器 27
- TV 和視頻裝置連接 21

## V

- VIDEO CD 33, 76

## W

- 無線廣播 61

## X

- 先進功能 53

## Y

- 揚聲器設定 67
- 揚聲器系統連接 16
- 遙控器 12, 59
- 用戶鎖定 54
- 預設電台 28, 61
- 語言設定 64

## Z

- 章 6, 39, 76
- 暫停模式 67
- 字幕 50, 64





